Official Vietnam

HYTORC BOLTING SOLUTIONS

HYTORC

The World's Most Trusted Industrial Bolting Systems

+84 2836 208 305 – hytorcvina.com

MAIN CONTENTS

1. ABOUT HYTORC

2. HYTORC SERVICES

3. HYTORC TOOL LINES

4. STRETCH TO LOAD TECHNOLOGY

5. INDUSTRIAL CUSTOMER & APPLICATIONS

MAIN CONTENTS

ABOUT HYTORC

ABOUT HYTORC

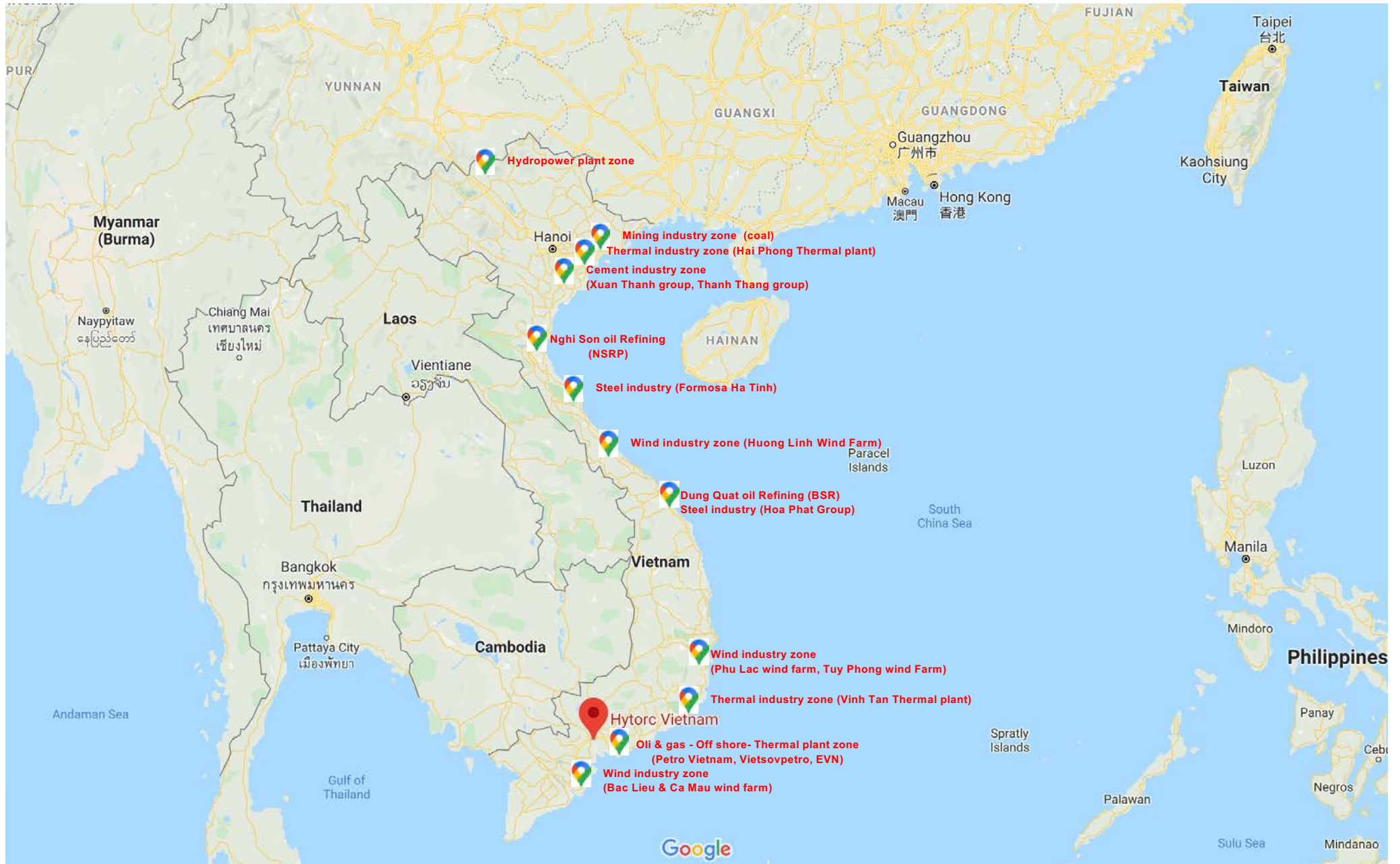

ABOUT HYTORC

HYTORC®

HYTORC, Division UNEX Corporation
333 Route 17N, Mahwah, NJ 07430, USA
Tel: (201) 512-9500 Fax: (201) 512-9615
Email: info@hytorc.com

TO WHOM IT MAY CONCERN

This is to certify that we at HYTORC, an ISO 9001 certified USA manufacturer of high quality tools for professional use, do hereby confirm:

HYTORC VIET NAM COMPANY LIMITED

Add: D01, Tan Thuan Rd, Tan Thuan EPZ, Tan Thuan Dong Ward, Dist 7, HCMC

Tel/Fax: +028 36 208305/07

Website: <https://hytorc.com/hytorc-locations>

is our authorized branch company in VIETNAM, and only they can market and sell HYTORC tools in VIETNAM, as well as give HYTORC's global after-sales & service to customer.

Thank you,



Tom Evans

Customer Support Manager

HYTORC USA

HYTORC
333 Route 17 North
Mahwah, NJ 07430

HYTORC

ABOUT HYTORC

HYTORC VIETNAM CO, LTD established in 2016 by Mr. Bruce Wu as a 100% foreign capital company approved by the Vietnamese government. Provide professional services such as sales, leasing, bolting solutions, maintenance, and training program.

HYTORC products have been widely used in heavy industrial industries : oil refining, power generation, petrochemical, steelmaking, shipbuilding, chemical, machinery, cement, mining, etc., and have been highly evaluated.

With 50 years of engineering fastening experience, we insist on providing safe, reliable and fast bolting technology for the industry to solve the problems of bolt loosening and flange leakage.

Uphold the core values of integrity, dedication, innovation, and win-win business.

ABOUT HYTORC

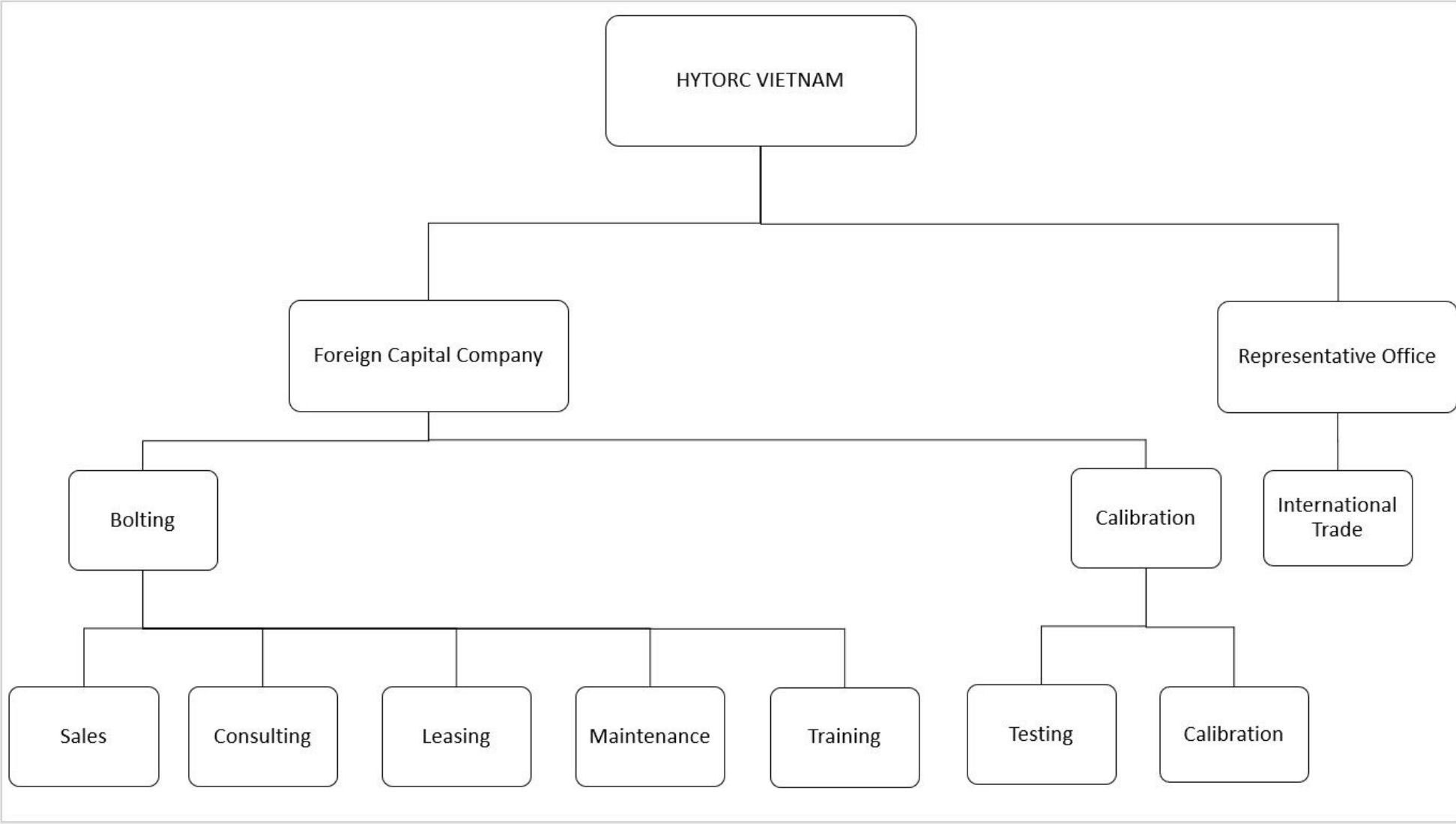

ABOUT HYTORC

Lai Ming Yuan
ASME Bolting Specialist
General Manager



Tran Nhat Truong
ASME Bolting Specialist
Sales Manager



Cao Thanh Lap
ASME Bolting Specialist
Customer Service
Manager

ABOUT HYTORC

Development by different period

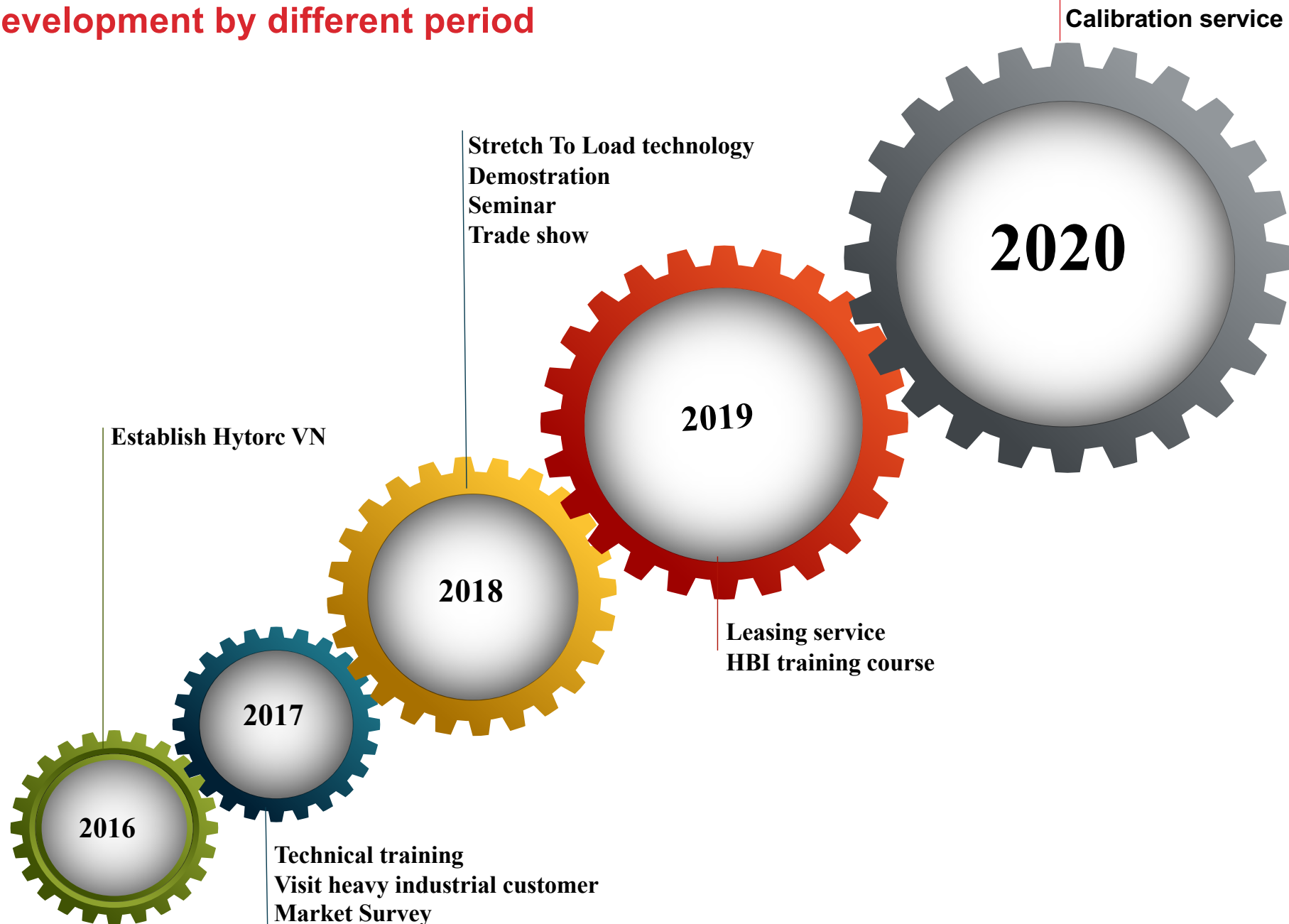

MAIN CONTENTS

HYTORC SERVICES

HYTORC SERVICES

Sales Tools and Accessories

Rental service (equipment, Hytorc engineer)

Bolting consulting

Warranty & Repair & Calibration service

Operation and Safety training

HYTORC SERVICES

Sales Tools and Accessories



HYTORC SERVICES

Rental service (Hytorc Equipment, Hytorc Engineer)



HYTORC SERVICES

Rental service (Hytorc Equipment, Hytorc Engineer)

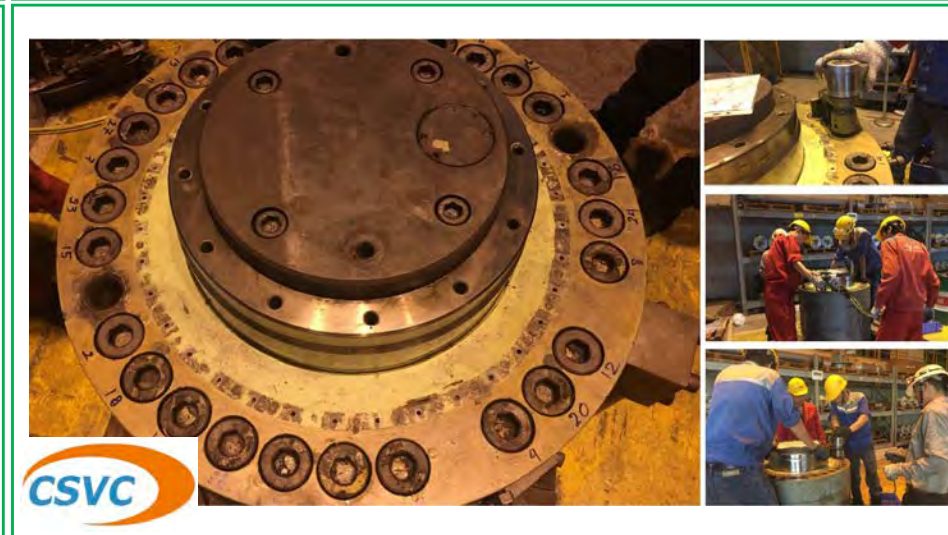
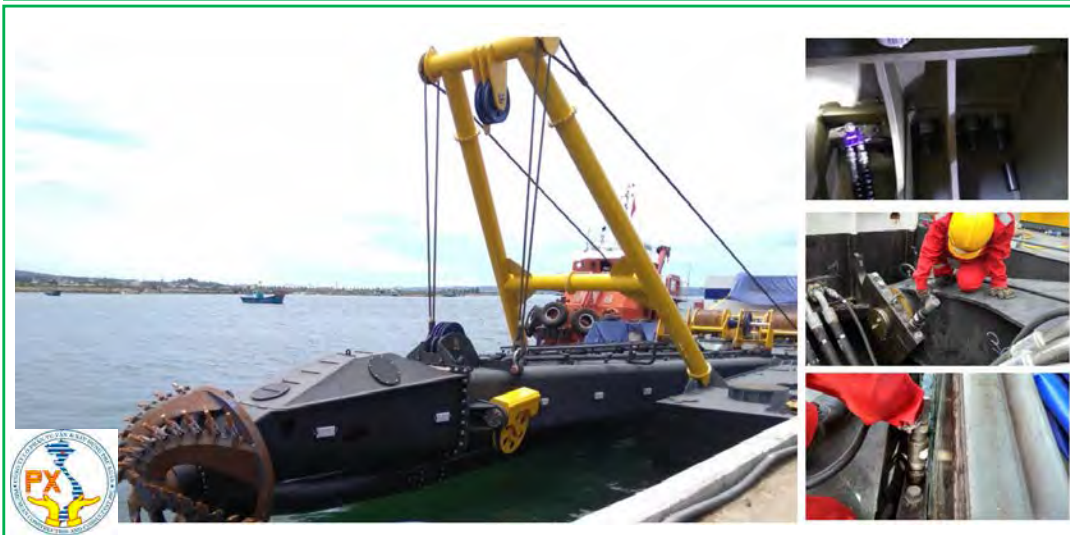

HYTORC SERVICES

Bolting **consulting**

Survey

Demonstration onsite

Solution provide



HYTORC SERVICES

Warranty & Repair & Calibration service

Warranty & Repair policy:

- 12 Months warranty on Electric Tools, Hydraulic and Pneumatic Tools.
- 3 Months warranty on all out of warranty service work.
- If the repair time is more than 2 working days, Hytorc will provide the same specifications products.
- No cost annual tool inspection.
- No cost upgrades during the lifetime of the tool.
- No cost first use half day supervision.
- No cost semi-annual user safety training.
- No cost bolting optimization consultation to improve job safety, quality, schedule.
- No cost product demonstration.

Calibration service:

- Hydraulic Torque Wrench Calibration Services at Hytorc VN officice
- For improved productivity, inventory management and operator safety, HYTORC mobile service technicians provide repairs, test and training at your location.



HYTORC SERVICES

Warranty & Repair & Calibration service

Calibration room:



HYTORC SERVICES

Warehouse



HYTORC SERVICES

Warehouse



HYTORC SERVICES

Operation and Safety training



MAIN CONTENTS

HYTORC TOOL LINES

HYTORC TOOL LINES

Hydraulic torque tools

Pneumatic torque tools

Electric torque tools

Bolt tensioner

Hydraulic torque tools

HYTORC TOOL LINE

Hydraulic torque tools

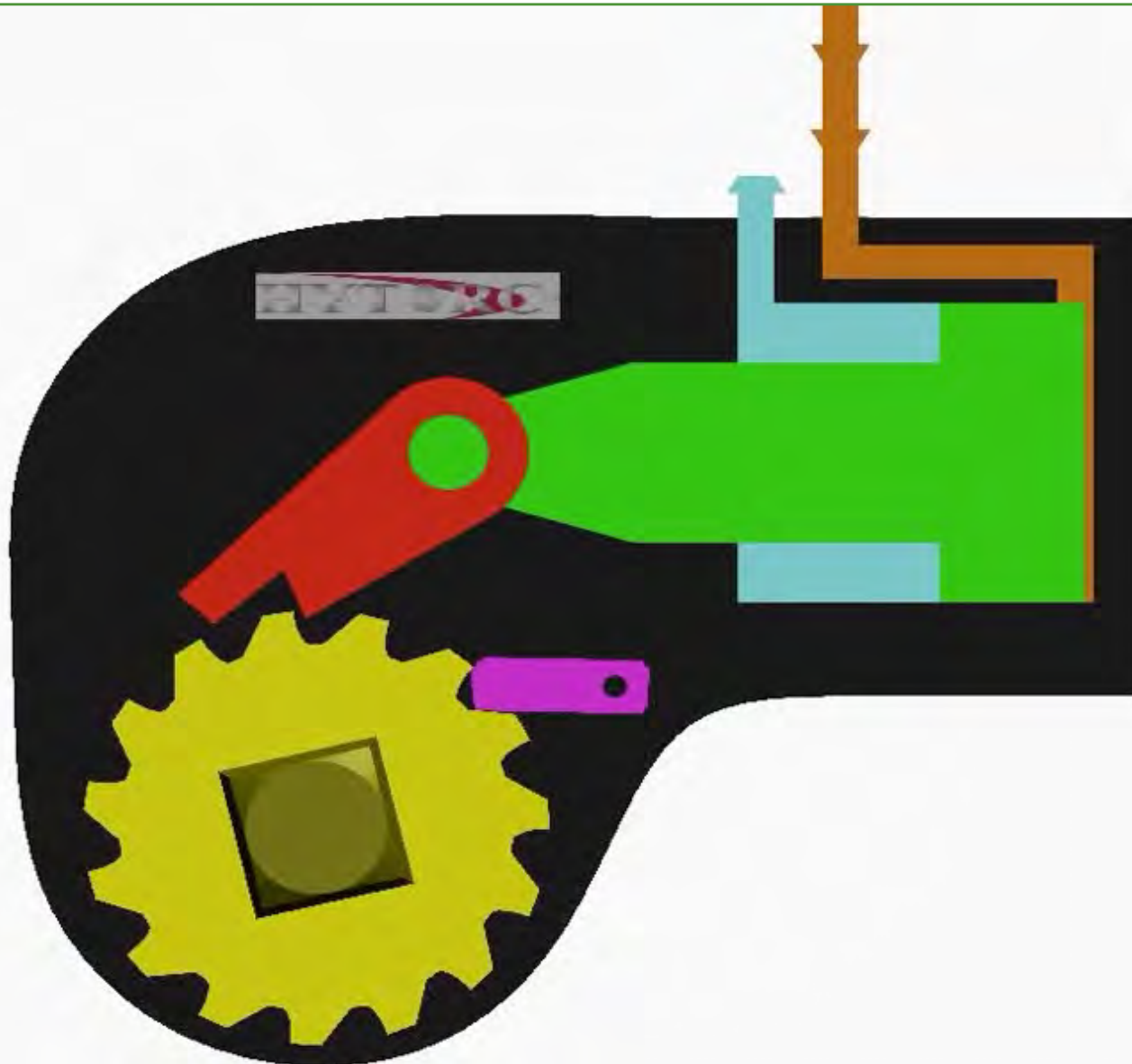

HYTORC TOOL LINE

Hydraulic torque tools

Hydraulic Torque Tool Technology

PUSH – ADVANCE – CLICK – RELEASE – Tool Drive Turns 24 degrees

PUSH

Pushing the advance button on the remote switches a solenoid valve on the pump and directs hydraulic fluid pressure into the advance side of the tool cylinder.

ADVANCE

Piston in the tool cylinder advances to turn the ratchet 24 degrees/click.
(some tool ratchets are different, the STEALTH turns 18 degrees/click)

CLICK

Ratchet locks in place against a pawl with a distinct clicking sound.

RELEASE - RETRACT

Releasing the advance button causes the solenoid valve to direct pressure in the release port to retract the piston.

REPEAT

This sequence is repeated until tool stalls at the desired pressure – nut stops turning.

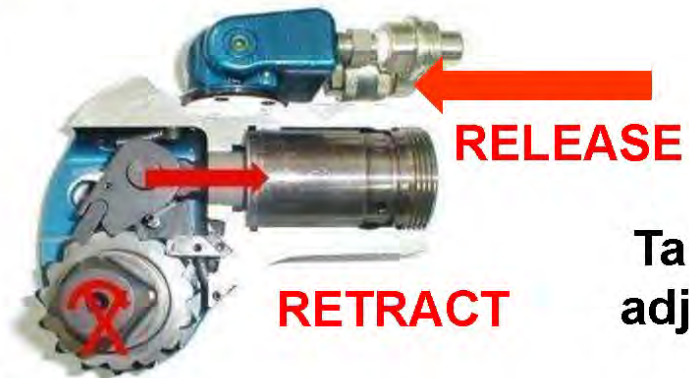
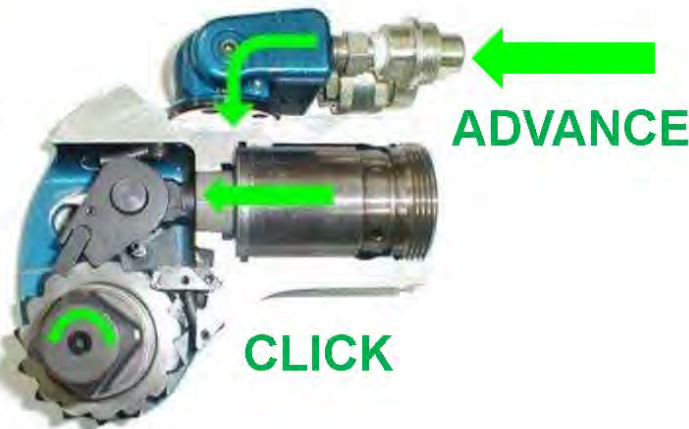

Target torque value is set by adjusting the pump pressure.

HYTORC TOOL LINE

Hydraulic torque tools

Hydraulic Tool Overview

Square Drive Tools



ICE

.7, 1, 3, 5

AVANTI

.7, 1, 3, 5, 8, 10,
20, 35, 50, 80, 130

CRITICAL PATH TECHNOLOGY

Safest, leak and
failure-free

HEAVY INDUSTRY TECHNOLOGY

Most widely used



MXT

.7, 1, 3, 5, 10, 15, 20, 35

MAINTENANCE TECHNOLOGY

Durable and
simple to maintain



EDGE

2, 4, 6, 8, 12, 30

Low Clearance Tools



STEALTH

2, 4, 14, 22, 36



XLCT

2, 4, 8, 14, 18, 30, 45



VERSA

1, 2, 4, 8, 14, 20, 30

Pumps



HY-115/230



HY-AIR



HY-VECTOR

Accessories



Pneumatic torque tools

HYTORC TOOL LINE

Pneumatic Powered Torque Tools



JGUN SINGLE SDEEP
.25, .5, 1, 2, 3, 5, 8



JGUN DUAL SDEEP
.5, 1, 2, 3, 5, 8



DIGITAL JGUN
.25, .5, 1, 2, 3, 5, 8



FRL

Electric torque tools

HYTORC TOOL LINE

Electric Powered Torque Tools



LION GUN
.25, .7



LITHIUM GUN
250, 700, 1000, 2000, 3000



LITHIUM GUN SERIES II
700, 1200, 2000, 3000, 5000

Bolt tensioner

HYTORC TOOL LINE

Bolt tensioner (UK Brand)



DQU-004 A

BS EN ISO 9001 : 2015 Certification

Registration Certificate

This document certifies that the Quality Management Systems of

**SECURE BOLTING SYSTEMS LTD
t/a TENSIONPRO**

*Have been assessed and approved by
CQS (Certified Quality Systems) Limited
to the following Management System Standard*

BS EN ISO 9001 : 2015

*The scope of this certification applies to the
Quality Management Systems relating to the following activities*

**THE DESIGN, MANUFACTURE & SUPPLY OF
HYDRAULIC BOLT TENSIONING & ANCILLARY EQUIPMENT**



Certificate Issued: 20th April 2020

Certificate No: GB2005580

Expiry Date: 19th April 2023

*Should verification of the validity of this certificate
be required please contact:*

*CQS (Certified Quality Systems) Ltd
United Kingdom Head Office: +44(0)1684 571350
email: verification@cqs Ltd*

On behalf of CQS (Certified Quality Systems) Limited

EAC 18

SIC 25730

This certificate remains valid while the holder maintains their Management Systems
in accordance with the guidelines above, which will be audited by CQS (Certified Quality Systems) Ltd or its nominee.
This certificate remains the property of CQS (Certified Quality Systems) Ltd and must be returned in the event of cancellation.

Bolt tensioner (UK Brand)

MAIN SCOPE:

- ❖ Latest technology tensioners and equipment
- ❖ Design, calculations and analysis
- ❖ Training and repair service

MAIN CONTENTS

STRETCH TO LOAD TECHNOLOGY

STRETCH TO LOAD TECHNOLOGY

THE HYTORC WASHER SYSTEM

DIRECTIONAL FORCES

USING A STANDARD REACTION FIXTURE

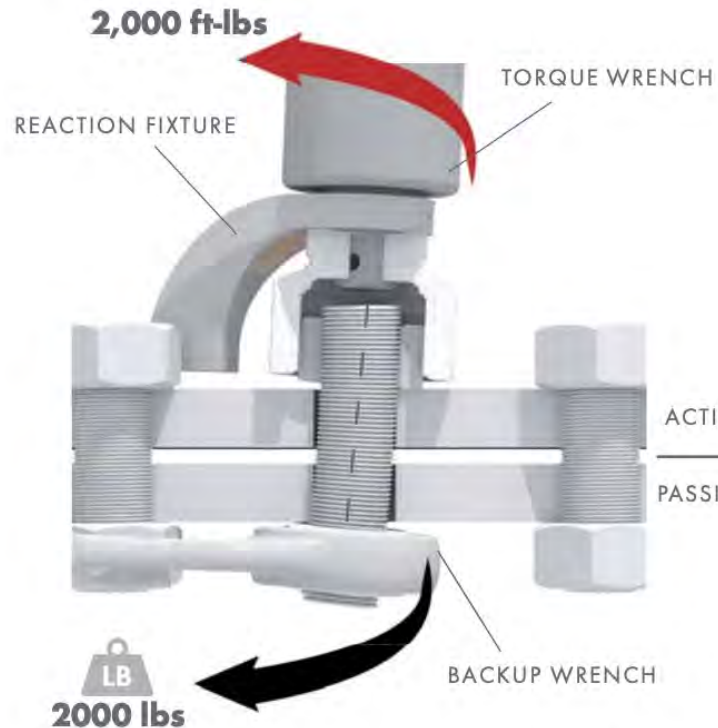

When the reaction fixture abuts away from the bolt's center axis, side loads and bending forces are applied to the bolt.

HYTORC WASHER WITH BACKUP WASHER

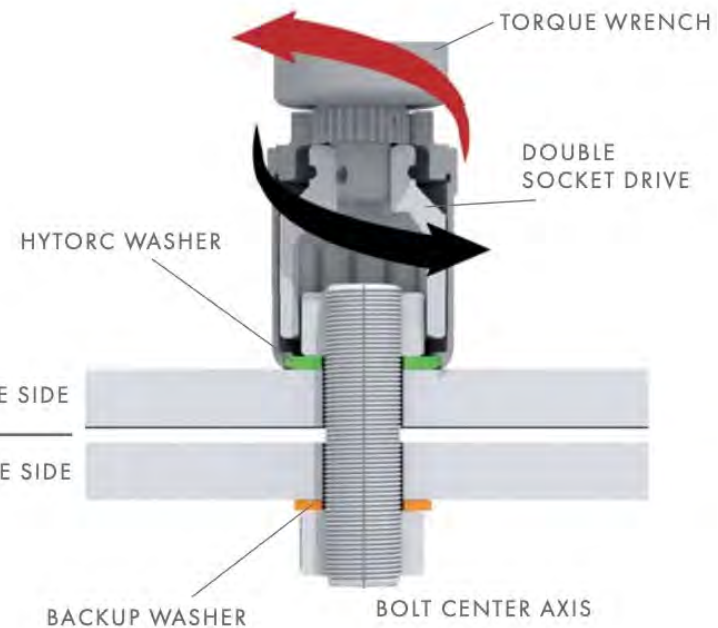

The HYTORC Washer enables coaxial bolting using a double drive socket. Action and reaction occur on the bolt's center axis.

STRETCH TO LOAD TECHNOLOGY

THE HYTORC WASHER SYSTEM

HYTORC WASHER SYSTEM



ACTIVE SIDE

The HYTORC WASHER starts the process improvement under the nut that the torque wrench is turning. Standard hydraulic, electric and air-powered torque tools need a reaction arm to abut against a fixed point. The HYTORC WASHER becomes the reaction point and eliminates the risk of hand injuries.

The HYTORC WASHER is simple and easy to use. Like every other hardened steel washer, the HYTORC Washer prevents flange surface damage and eliminates variables in friction by making the turning surface uniform across the flange.



PASSIVE SIDE

On the side opposite of the nut being turned there is often a counter nut. To prevent rotation with the bolt, this nut needs to be kept stationary by a backup wrench that abuts against a solid object. HYTORC continues the process improvement with the BACKUP WASHER, which eliminates the use of a backup wrench.

Backup wrenches add dangerous pinch points to the job; they are also inconvenient and time consuming. The BACKUP WASHER is an inexpensive alternative that can provide major improvements in safety and speed, usually leading to a return on investment after the first use.

The HYTORC WASHER SYSTEM consists of the HYTORC WASHER combined with the BACKUP WASHER. Both washers can also be used independently. Bolting has never been this safe!

STRETCH TO LOAD TECHNOLOGY

THE HYTORC WASHER SYSTEM

CONVENTIONAL METHOD

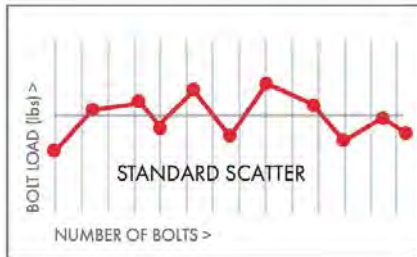

HYTORC WASHER SYSTEM

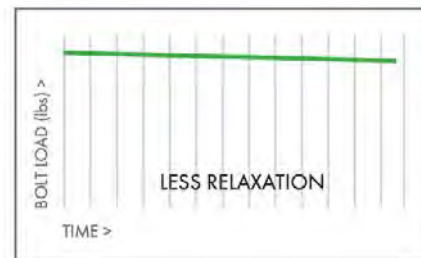
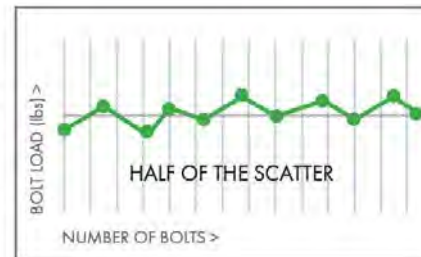

SAFETY

No pinch hazard.
Intuitive operation.
Less personnel.

EQUAL BOLT LOAD

The coefficient of friction and thus the bolt load, depends on many factors. With the WASHER SYSTEM the scatter in bolt load is cut in half.

DURABILITY

Through-hardened washers reduce surface pressure, resulting in decreased relaxation. This keeps bolt load intact over time.

ECONOMICAL

By eliminating damaging side loads and bending forces, nuts and bolts can be reused more often and flange longevity is increased.

STRETCH TO LOAD TECHNOLOGY

THE HYTORC WASHER SYSTEM

CONVENTIONAL METHOD

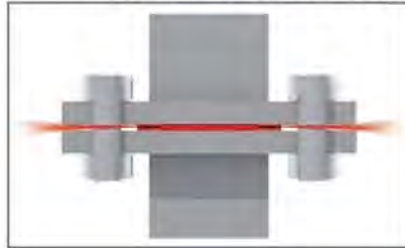

LEAKAGE

Even and accurate bolt load applies even pressure to the gasket, improving joint integrity and reducing the chance of leakage.

HYTORC WASHER SYSTEM

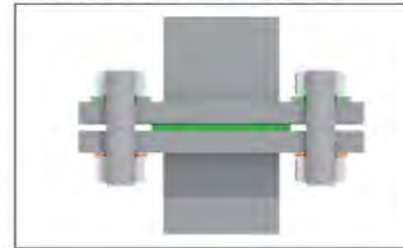

SPEED

Job time is reduced through intuitive processes and the elimination of time consuming tasks like setting up reaction fixtures and removing backup wrenches by hammer.



FLANGE SURFACE

The HYTORC Washer protects the flange surface, eliminating the need for expensive flange resurfacing processes.



WASHER

For a complete solution, choose the HYTORC WASHER SYSTEM.



MARKETING

HYTORC VIETNAM Website

HYTORC®

TRANG CHỦ HỆ THỐNG THIẾT BỊ THÔNG TIN KỸ THUẬT DỊCH VỤ VÀ HỖ TRỢ THÔNG TIN CÔNG TY

Introducing...
THE HYTORC®
WASHER

Zalo

WhatsApp

24/7 LIVE SUPPORT
1-800-FOR-HYTORC

HYTORC
SINCE 1988

INDUSTRIAL BOLTING SOLUTIONS

HYTORC
UNIVERSITY

Support

HYTORC®

MARKETING

HYTORC VIETNAM Youtube Channel

The screenshot displays the YouTube channel page for Hytorc Vietnam. The channel has 63 subscribers and is currently subscribed to. The page shows a grid of video uploads, including:

- Hytorc Việt Nam tại POSCO VINA - Thao tác tại m...** (3.9K views • 4 years ago, 6:49)
- Hytorc Việt Nam Demo trực tiếp tại Nhà máy Nhiệt điện...** (2.8K views • 3 years ago, 5:23)
- Phú Thái Cát sử dụng Jgun A3-AP để xiết hệ thống...** (2.3K views • 3 years ago, 2:06)
- HYTORC VIỆT NAM - VIDEO BẢNG TRA LỤC XIẾT...** (785 views • 1 year ago, 16:41)
- HYTORC VIỆT NAM - Thao siết bu lông máy nghiền bi - ...** (784 views • 4 years ago, 3:10)
- Hytorc Demo thiết bị Jgun A1AP tại Nhiệt Điện Long...** (645 views • 3 years ago, 0:57)
- Hytorc Việt Nam - Lithium gun (Cờ Lê Pin BTM 1000)** (600 views • 4 years ago, 1:23)
- Hytorc Việt Nam tại nhà máy ALUMIN Lâm Đồng Part 1** (483 views • 4 years ago, 12:19)
- HYTORC Việt Nam tại nhà máy Mía đường Thành Thành...** (475 views • 3 years ago, 14:25)
- Hytorc Việt Nam tại thủy điện A Vương - Cờ lê thủy lực dạ...** (471 views • 4 years ago, 6:46)

The left sidebar shows navigation options like Home, Trending, Subscriptions, Library, History, Your videos, Watch later, Favorites, Liked videos, Tin mới nhất, and Show less. The bottom of the page features the Hytorc logo.

SALES IN WIND AND THERMAL POWER

WIND INDUSTRIAL	THERMAL POWER
ĐIỆN GIÓ BẠC LIÊU (GE Turbine) – CTY CÔNG LÝ	NHIỆT ĐIỆN KHÍ CÀ MAU
ĐIỆN GIÓ TUY PHONG (FURHLANDER Turbine) - REVN	NHIỆT ĐIỆN VĨNH TÂN 2
ĐIỆN GIÓ PHÚ LẠC (VESTAS Turbine)	NHIỆT ĐIỆN VĨNH TÂN 4
ĐIỆN GIÓ ĐẠI PHONG (VESTAS Turbine)	NHIỆT ĐIỆN MÔNG DƯƠNG 1
ĐIỆN GIÓ HỒNG PHONG (GE Turbine)	NHIỆT ĐIỆN PHÚ MỸ 2.2
ĐIỆN GIÓ HƯỚNG LINH 1 & 2 (VESTAS Turbine)	NHIỆT ĐIỆN PHÚ MỸ
ĐIỆN GIÓ HƯỚNG PHÙNG 1 & 2 & 3 (VESTAS Turbine)	NHIỆT ĐIỆN VŨNG ÁNG
ĐIỆN GIÓ QUẢNG BÌNH B&T (VESTAS Turbine)	NHIỆT ĐIỆN PHẢ LẠI
ĐIỆN GIÓ PHƯƠNG MAI 3 (GE Turbine)	NHIỆT ĐIỆN HẢI PHÒNG
ĐIỆN GIÓ TRÀ VINH 1 (VESTAS Turbine)	NHIỆT ĐIỆN DUYÊN HẢI
ĐIỆN GIÓ DUYÊN HẢI (VESTAS Turbine)	NHIỆT ĐIỆN NGHI SƠN

OUR CUSTOMER

Our Partner:



EVNGENCO 3
TPC PHU MY



EVN EPS



EVNGENCO 2
HPC A VUONG



OUR CUSTOMER

Our Partner:

**DAMEN
SONGCAM**



Pharung Shipyard



NASICO



OUR CUSTOMER

Our Partner:



HYTORC makes industrial bolting safer and simpler. Contact HYTORC today to find out how we can optimize your bolting processes.

Contact Info:

HYTORC VIETNAM Co, LTD.

ADDRESS: D01, Đường Tân Thuận, KCX Tân Thuận,
Phường Tân Thuận Đông, Quận 7, TP.HCM

Number: (028) 36 208 305

Fax: (028) 36 208 307

[Email:info@hytorcvina.com](mailto:info@hytorcvina.com)