

LSELECTRIC FUTURING SMART ENERGY

We open up a brighter future through efficient and convenient energy solutions.

FUTURING

We are leading the way towards a new future through innovations that exceed our customers expectations.

SMART

We are creating an efficient convenient future through ICT convergence and the integration of sophisticated technologies.

ENERGY

We are creating an abundant future by delivering safe clean energy.



Power / Automation Sector
Total Solution Provider



Smart Grid, Smart Factory, Smart Building
Solution Leading Company



Smart Energy Global Leader
including ESS, EMS, HVDC, P

CONTENTS

- 01 LS Group
- 02 LS ELECTRIC
- 03 Business Overview
- 04 Global Operations
- 05 Referential Projects
- 06 Exhibition
- 07 History

Phương châm: Đồng hành cùng khách hàng và Cùng nhau tạo ra giá trị lớn hơn

LS Group is a conglomerate based in South Korea. It spun off from LG Group in 2003.

LS is leading in the field of electric power, automation, machinery, materials and energy.

Tiền thân là thành viên trong tập đoàn LG, LS group được tách ra từ năm 2003.

LS tự hào đi đầu trong lĩnh vực sản xuất thiết bị điện, cung ứng giải pháp tự động hóa, máy móc, vật tư và năng lượng

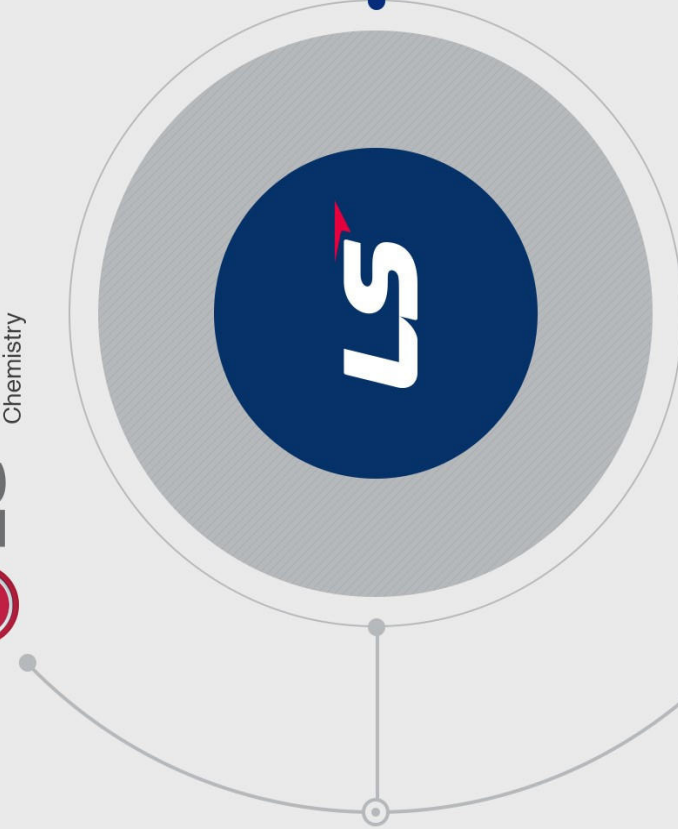

LS Group

EMPLOYEES	12,700
AFFILIATES	48
SALES	22.9 B USD
TOTAL ASSET	22.6 B USD



LS ELECTRIC [1974]

EMPLOYEES	3,500
SALES	1.9 B USD
OPERATION INCOME	150 M USD

* Financial figures in 2019

LS ELECTRIC is the pioneer of electric power system, automation, and green energy industry in South Korea.

LS Electric là nhà tiên phong trong việc sản xuất thiết bị điện, giải pháp tự động hóa và kiến tạo ngành công nghiệp năng lượng xanh ở Hàn Quốc

Company Name LS ELECTRIC CO., LTD.

Founded 1974

Employees 3,500

Total Assets 2,170(In millions of USD, 2019)

Headquarters LS Tower, LS-ro 127, Dongan-gu, Anyang-si, Gyeonggi-do, Korea

Seoul office LS Yongsan Tower, Hangang-daero 92, Yongsan-gu, Seoul, Korea

Plants 4 in Korea, 2 in China and 1 in Vietnam

Global Manufacturing Footprint

Global manufacturing footprints and top-notch R&D centers allows LS ELECTRIC to produce global top level products with unparalleled cost competitiveness

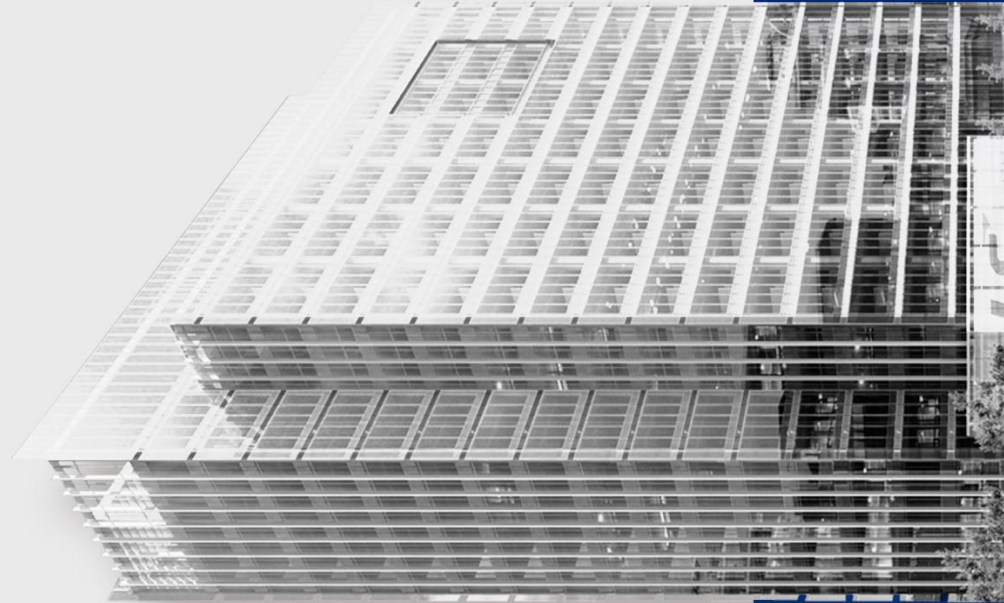

“Great Company Prospering for 100 years”

Our goal is to go beyond global standard through constant quality improvement and innovation.



Clarivate
Analytics

Top 100 Global Innovator
for 9 consecutive years

[2020]

| R&D Campus_Anyang



R&D Campus is consistently developing differentiated technologies and software in new business sectors as a future growth engine. We sharpen our competitive edge by developing next generation platform, to provide total energy solution service.

| Electronic Power R&D Center_Cheongju



R&D Center is the main laboratory for electrical power solution business of LS ELECTRIC. Our focus is to lead smart energy & smart factory industry from transformation to distribution, which is the core business value of LS ELECTRIC.

Ensuring product quality and reliability
Đảm bảo chất lượng và độ tin cậy của sản phẩm

Power Testing & Technology Institute of LS ELECTRIC

The first private testing center equipped with a short-circuit, high-voltage test system with a capacity of 2000MVA, 170kV 50kA.

Type test results issued by PT&T are recognized by the Association of STL members around the world.

Là trung tâm thử nghiệm tư nhân đầu tiên trang bị hệ thống thí nghiệm dòng ngắn mạch, thí nghiệm cao áp với công suất 2000MVA, 170kV 50kA.

Kết quả thử nghiệm Type test do PT&T ban hành được công nhận bởi Hiệp hội các thành viên STL trên thế giới.



BUSINESS OVERVIEW - TỔNG QUAN HOẠT ĐỘNG KINH DOANH

LS Electric is proud to provide comprehensive products and solutions for the energy sector, from Production - Transmission - Distribution - and especially the field of smart energy. Automated applications in the energy industry, water treatment, and railway operations

Power T&D

HVDC
GIS 420kV 6300A
Power TR 550kV 800kVA,
Switchgear 40.5kV-50kA
Circuit breakers
Contactors & Relay



Automation

DCS
PLC
HMI
Drive
Server



Smart Energy

PV system
Power conditioning system
Battery Energy Storage system
EMS
Balance of Plant



LS Electric tự hào cung cấp sản phẩm và phát triển giải pháp đồng bộ cho ngành năng lượng, từ Sản xuất – Truyền tải – Phân phối – và đặc biệt là lĩnh vực năng lượng thông minh.

Tự động hóa ứng dụng trong ngành năng lượng, xử lý nước, và vận hành đường sắt

SMART ENERGY BUSINESS

LS Electric: Total Solution provider & coverage for whole Smart Energy system

Energy Storage

Solar

O&M



Power capacity 896MW+
Energy capacity 1.42GWh+

Turn-key projects 230MW+
Floating Solar 12MW+

Operating projects 15+
O&M sites PV 65MW+ / ESS 250MWh+

* Install base as of Feb, 2020

December 2018: LSIS, part of the \$20B LS Group, acquires Parker Hannifin's Energy Grid Tie division



Smart Factory



01

LS ELECTRIC has established the smart factory solution with IoT technologies in Cheongju Plant, where low voltage circuit breakers and switches are manufactured.

The solution has been applied to the production lines and has completed the automation of entire process from assembly, inspection to packaging.

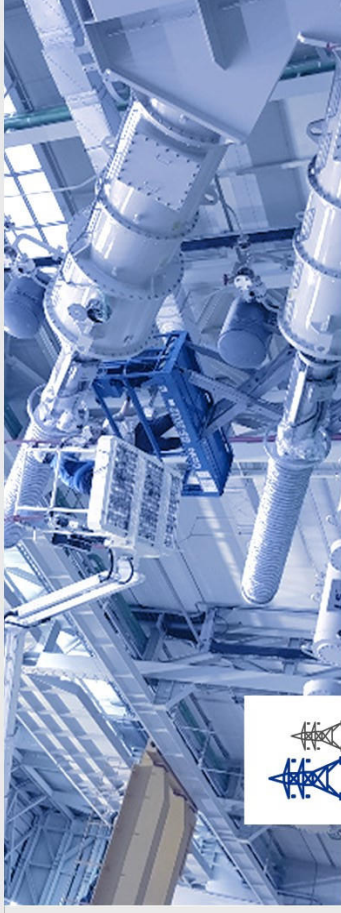

02

Incheon/Gimpo Airport Boarding Bridge Control System

LS ELECTRIC established the boarding bridge control automation systems in the two largest airports in South Korea. (Incheon International Airport and Gimpo International Airport, 2015)

The project helps the airport central monitoring offices to monitor/manage airplane data and control boarding bridges through high-speed links and long-distance communication system under the applications of LS ELECTRIC's SCADA and XGT PLC.

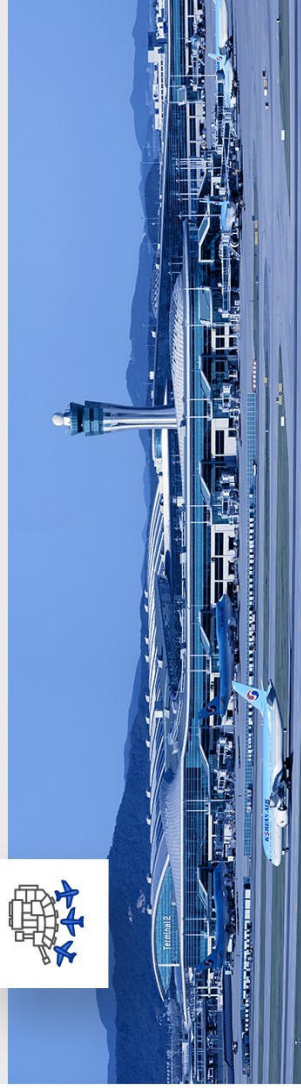
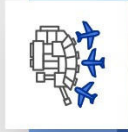

03

HVDC/FACTS Project

LS ELECTRIC established the HVDC manufacturing plant in Busan(2011).

Its competitiveness and quality have been recognized by winning contracts of the HVDC facility conversion projects of North Dangjin ~ Godeok (2014) and Eastern Coast ~ Shingapyeong (2018) in South Korea.

04

First and Largest Mega Solar Project of Japan

In 2009, LS ELECTRIC entered the Japanese photovoltaics market as a first Korean company.

- The largest 40MW Mito New Town mega solar power station in Ibaraki Prefecture
- The first 39MW solar power station with ESS in Chitose, Hokkaido
- 18MW Hanamizuki mega solar power station in Ishikawa Prefecture
- Won the Morioka Solar Plant 50MW contract in 2019

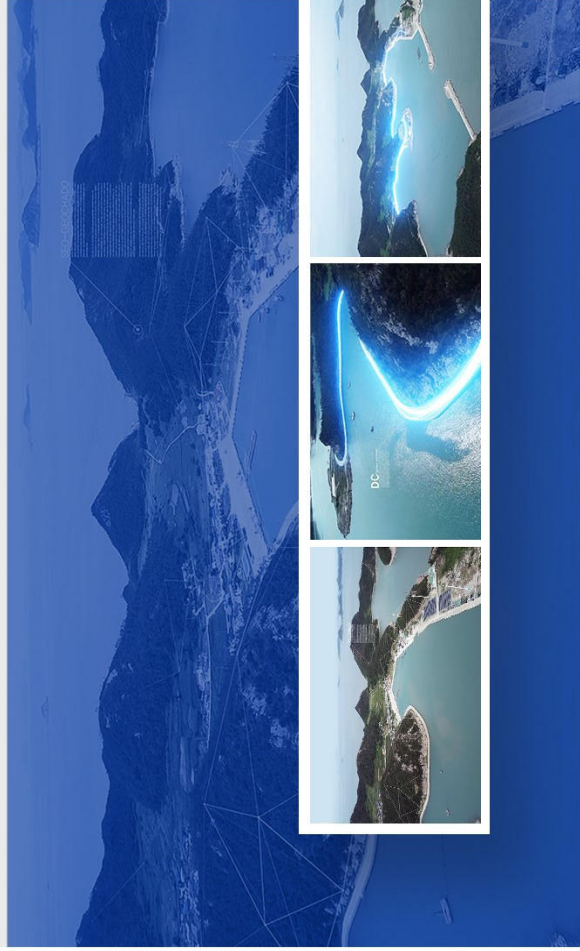
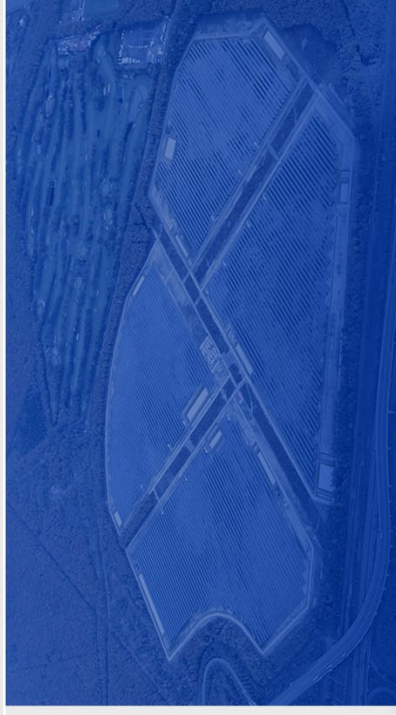

05

World's Largest DC Island Project

LS ELECTRIC has built the largest DC island in the world (2019). Through this project, this new renewable energy system which generates direct current such as photostatic power generation can be linked directly to the energy storage system and other battery facilities of mainland.

❖ Power Generation Plants:

- Coal fire power plants: Supply whole auxiliary power system for **10GW plants in Vietnam**: Mông Dương 1, 2, Nghi Sơn 2, Long Phú 1, Vinh Tân 4 & Extension, Cam Pha, Hai Duong, Thai Binh ...
- **6GW Mid-east Asia** : Talin (Taiwan), TVEP+Balingasag (Phil), Melaka (Malay), Matarbari (Bangladesh), Pulau Indah, Fujaira (UAE), Cirebon & Sarrule (Indo)
- 1GW Hydro & Renewable energy: Hydro, Solar, Wind...

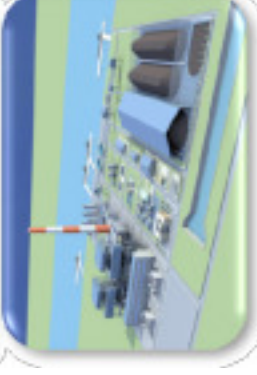

❖ Power Transmission:

- 1st Gas Insulated substation in Vietnam: Bờ Hồ 110kV GIS-1998, 110kV Tân Sơn Nhất, 110kV Quận 6, 110kV Tân Bình 2
- Over 100 EVN substations: 110-220kV



- ❖ LSEVN the 1st & leading manufacturer of Electrical Switchgear, Transformer, Non-segregated phase busduct in Vietnam with 24 /7 customer service to accompany with Owner in operation.
- ❖ Total engineering for products & solution provider to commit longer & stable warranty: 5 years for Transformer.



LS ELECTRIC | Vietnam

A member of LS ELECTRIC group / Một thành viên của Tập đoàn LS ELECTRIC
New name of LSISVINA / Tên mới của LSISVINA



R&D campus
[Korea]



LS Beijing RD center
[China]



Cheongju R&D center
[Korea]



Cheonan R&D center
[Korea]



Wuxi factory
[China]



Dallan factory
[China]



Cheongju factory
[Korea]



Cheonan factory
[Korea]



Busan factory
[Korea]



LS ELECTRIC Head Office
[Yongsan, Korea]



Busan RD center
[Korea]



PT & T institute
[Korea]



Hanoi factory
[Vietnam]

Business overview

(Thông tin chung)

Foundation & development
(Thành lập & phát triển)

LS ELECTRIC VIETNAM IS THE FIRST GENERATION OF FOREIGN INVESTMENT, FIRST SWITCHGEAR MANUFACTURING IN VIETNAM
(LS ELECTRIC VIỆT NAM là thế hệ công ty vốn đầu tư nước ngoài đầu tiên, nhà sản xuất tủ điện đầu tiên của Việt Nam)



Company name (tên công ty): LS ELECTRIC VIET NAM Co., Ltd

Foundation (thành lập): 3 April 1997

Capital (vốn đầu tư): 8 million USD

Employee (quy mô lao động): 220

Factory (nhà máy): Nguyen Khe, Danganh, Hanoi

Hanoi office (vp Hà Nội): 347 Hoang Quoc Viet, Cau Giay, Hanoi

Hochiminh (vp Hồ Chí Minh): 35 Tan Duc Thang, District 1, Hochiminh

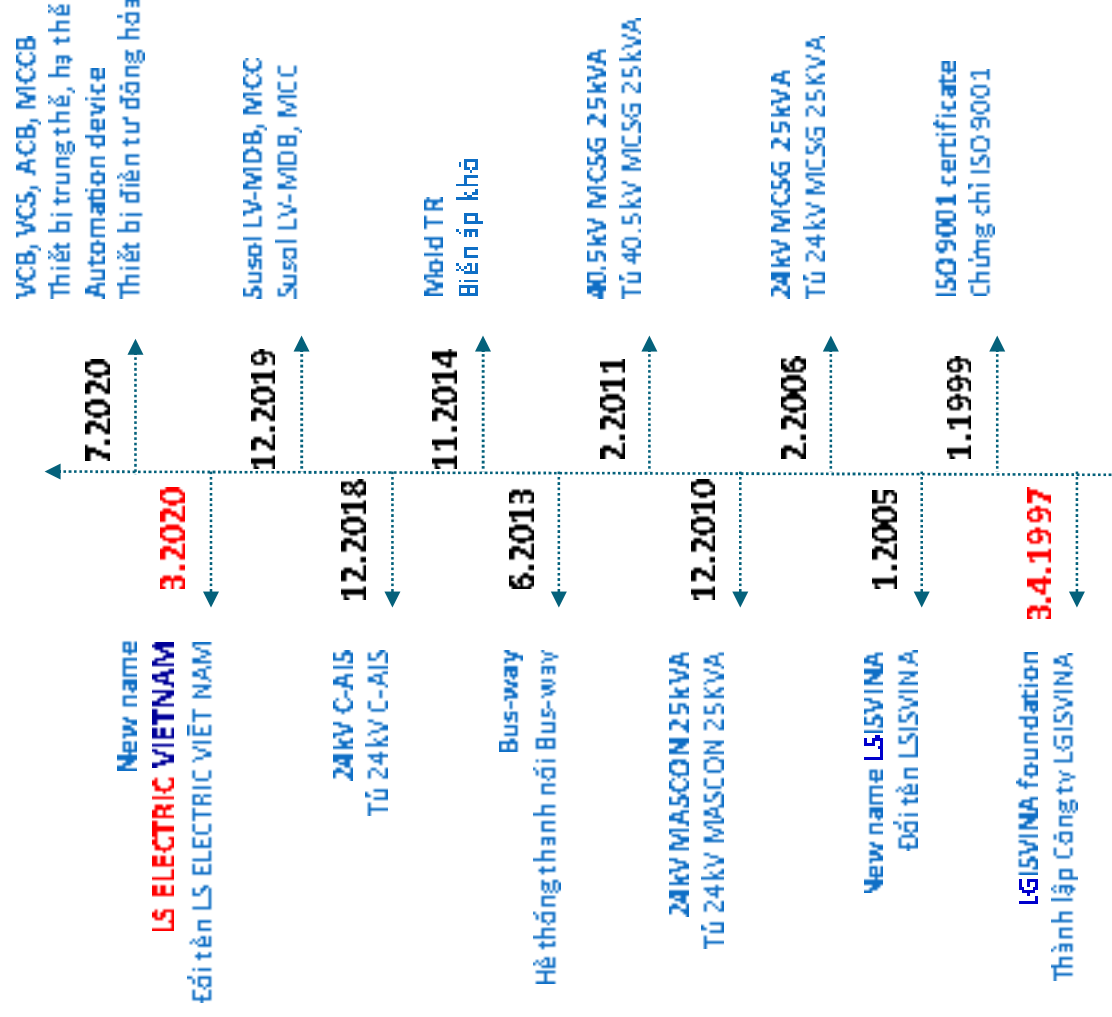

Factory

(Nhà máy sản xuất)

LS ELECTRIC

Factory (tổng diện tích nhà máy):

85 m x 156.5m = 13.302 m²

Road (đường đi):

25 m x 28m = 625 m²

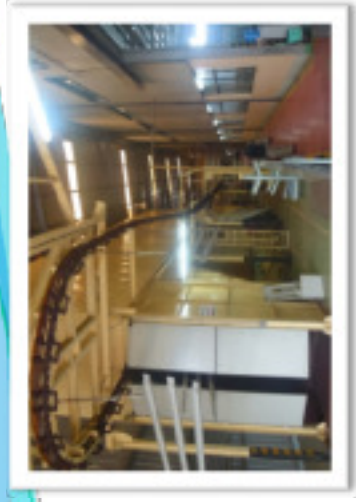

Powder painting
Dây chuyền sơn tĩnh điện



wiring / công đoạn đi dây



Fabrication
Gia công cơ khí



Bus-bar fabrication
Gia công thanh cái

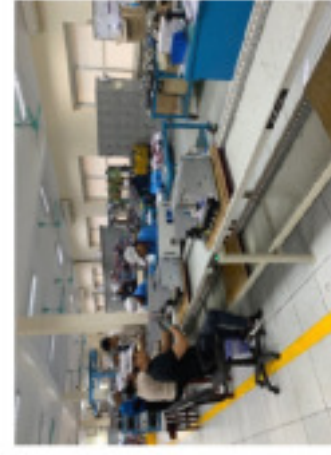

Modules assembly
Lắp ráp cụm chi tiết



SPS assembly line
Dây chuyền lắp ráp liên hoàn

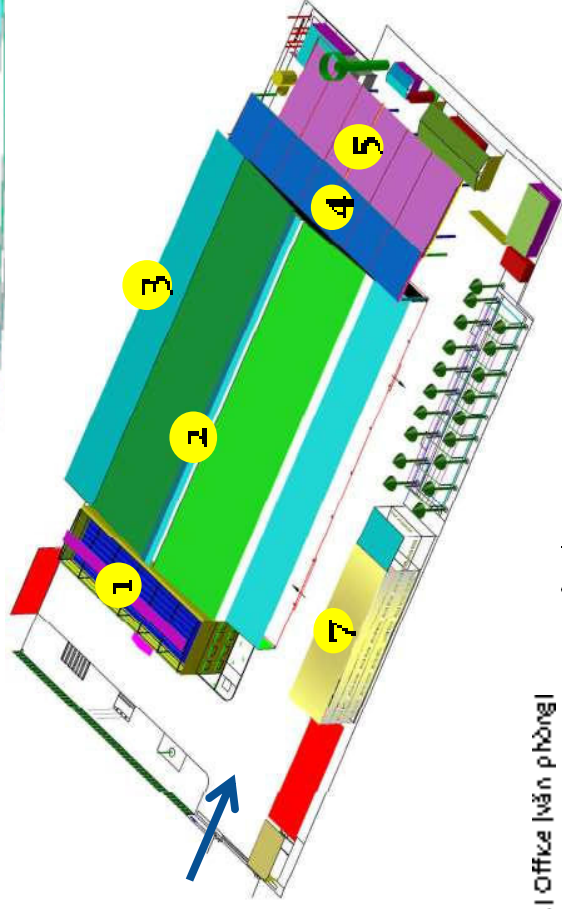

Capacity (năng lực sản xuất)

Key Model	Pn/Year
MV SWGR (tủ trung thế)	2,500
LV SWGR (tủ hạ thế)	1,500
MCC (tủ điều khiển)	2,500
TR (máy biến áp)	150

Products and application

(Sản phẩm và ứng dụng)

Manufacturing and distribution by LS ELECTRIC VIETNAM
(LS ELECTRIC VIỆT NAM trực tiếp sản xuất và phân phối)



MV

Switchgear
(Tủ trung thế)

VICSG
(Metal Clad)



VIESG
(Metal Enclosed)



C-AIS
(Compact-Air Insulated)



RMU
(Compact Ring Main Unit)



LV

Switchgear
(Tủ hạ thế)

SUSOL LV SWGR & MCC
(SUSOL LV & Motor Control Center)



Solution 2000 MCC
(Solution 2000 Motor Control Center)



SUSOL LV MDB
(SUSOL LV Main Distribution Board)



AC LV drive panel
(AC LV drive panel)

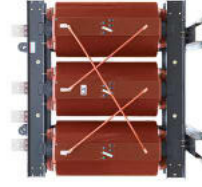

Dry Transformer
(Máy biến áp khô phân phối)





Cast Resin Transformer
(Máy biến áp khô)







NSPB
(Hệ thống thanh dẫn)



GIS
(Hệ thống tủ cách điện khí SF6)

Type Loại	MV – MMSG (Medium Voltage – Metal Enclosed Switchgear) (tủ trung thế có thiết bị chia khoang)	MV – MMSG (Medium voltage – Metal Enclosed Switchgear) (tủ trung thế không khoang ngăn cách)	MV/C-AIS (Compact-Air Insulated Switchgear) (Tủ trung thế tích gọn cách điện bằng không khí)	RMU (Ring Main Unit Switchgear) (Tủ trung thế tích gọn cách điện bằng khí SF6)
Photos (Hình ảnh minh họa)				
Applications (phạm vi ứng dụng)	<ul style="list-style-type: none"> • 3.6kV, 7.2kV, 12kV, 24kV up to 40.5kV • Incoming PNLs for Power Plant, Substations, Factories • IEC Type Test Reports • VCBs & Protection Relays 	<ul style="list-style-type: none"> • 7.2kV, 12kV, 24kV • Incoming PNLs for Power Plant, Substations, Factories • Bolted Type Enclosure • VCBs & Protection Relays 	<ul style="list-style-type: none"> • 24kV Compact MMSG • Incoming PNLs for high-rise buildings • Suitable for small S/S 	<ul style="list-style-type: none"> • 12kV, 17.5kV, 24kV, 36kV Compact MMSG • Ring main panel for Infrastructure • Suitable for small S/S
Specifications (Đặc tính kỹ thuật)	<ul style="list-style-type: none"> • Separated compartments (Category LCS-2C) • VCB/PT Withdrawal • 12kV: 50kA/3s • 24kV: 31.5kA/3s • Protection Degree: IP41 	<ul style="list-style-type: none"> • Separated Compartments (Category LCS-1) • VCB/PT Withdrawal • 25kA Short Time Current • Protection Degree: IP41 	<ul style="list-style-type: none"> • IEC 6 2271-200 applied • Rated Short Time Current: 25kA/1sec • Protection Degree: IP3-X • SF6 Gas LBS + VCBs 	<ul style="list-style-type: none"> • IEC 62271-200 applied • Rated Short Time Current: 21kA/3 sec • Protection Degree: IP 3X: on front face, IP67 for SF6 tank • SF6 Gas Insulator
Capacity (năng lực sx)	200 PNLs/Month	200 PNLs/Month	300 PNLs/Month	400 PNLs/Month

<p>Type Loại</p>	<p>Susol LV-SWGR & MCC (Susol Low Voltage Switchgear & Motor Control Center) (tủ hạ thế chia khoang và điều khiển trung tâm)</p>	<p>IV / Solution 2000 MCC (Motor Control Center) (tủ hạ thế điều khiển mô tơ)</p>	<p>Control & Protection Panel (tủ bảo vệ, điều khiển)</p>
<p>Photos (Hình ảnh minh họa)</p>			
<p>Applications (phạm vi ứng dụng)</p>	<ul style="list-style-type: none"> • LV SWGRs - LV Distribution under 660V • PNLs for LV feeders in factories, buildings • ACBs & MCCBs 	<ul style="list-style-type: none"> • High rated current of ACB incomer and bus bar up to 4000(6300)A • Form4b feeder • Withdrawal MCC unit • IEC Type Test Reports • Unit Arc Test fulfilled • ACBs & MCCBs 	<ul style="list-style-type: none"> • Controls & Monitoring of Electrical Substations • Combined SCADA or S/S Automation Systems • Protection for HV S/S equipments of TL, Bus bar, TR Feeder and MV SWGRs
<p>Specifications (Đặc tính kỹ thuật)</p>	<ul style="list-style-type: none"> • Rated Voltage: 380 ~ 660 V • Rated Current of Main Bus Bar: 600 ~ 6300A 	<ul style="list-style-type: none"> • Mechanical/Electrical interlock available • Short Time Current: 65kA 	<p>-</p>
<p>Capacity (năng lực sx)</p>	<p>200 PNLs/ Month</p>	<p>100 PNLs/ Month</p>	<p>100 PNLs/ Month</p>

Type Loại	Cast Resin Transformer (Máy biến thế nhựa đúc)	Bus Duct (Hệ thống thanh nối)	GIS (Hệ thống tủ cách điện khí SF6)
<p>Photos (Hình ảnh minh họa)</p> 			
<p>Applications (phạm vi ứng dụng)</p>	<ul style="list-style-type: none"> ▪ Optimized enclosure for Mold Transformer (AL/CU) ▪ Various secondary connections of incomer bus bar, Bus duct & Cable ▪ Best cooling performance with Mesh ventilated door ▪ IEC Type test reports 	<ul style="list-style-type: none"> ▪ Greater reliability electrically and mechanically ▪ Economically feasible through minimizing the power loss ▪ Ease of installation and maintenance 	<ul style="list-style-type: none"> ▪ For Power Transmission & Distribution ▪ Compact Design to save Space ▪ High Reliability & Safety ▪ Long Life and Minimal Maintenance Cost
<p>Specifications (Đặc tính kỹ thuật)</p>	<ul style="list-style-type: none"> ▪ Rated Voltage: HV up to 35kV, LV up to 600V ▪ 50kVA up to 15,000kVA ▪ F Class (H Class available) 	<ul style="list-style-type: none"> ▪ Rated Voltage : up to 36kV, ▪ Rated Current : up to 4000A ▪ Protection Degree: IP53 -outdoor, 41 indoor 	<ul style="list-style-type: none"> ▪ Rated Voltage : 25.8/36kV, 72.5kV, 145kV, 170kV, 245kV, 362kV, 420kV ▪ Rated Current : up to 6300A, 50kA
<p>Capacity (năng lực sx)</p>	<p>150 Sets/Month</p>	<p>1000 module/Month</p>	



Hàm Thuận - Damli hydro power plant (Bình Thuận) 300MW
 Nhà máy thủy điện Hàm Thuận – Đa Mi (Bình Thuận), 300MW

In 1999, LSISVINA (former name of LS ELECTRIC VIETNAM) as the first foreign invested switchgear manufacturer in Vietnam has provided switchgears, indoor/outdoor accessories for the key national project, Hàm Thuận – Đa Mi power plant, 300MW

Năm 1999, LSISVINA (tên cũ của LS ELECTRIC VIỆT NAM), nhà sản xuất tủ bảng điện đầu tiên ở Việt Nam, đã cung cấp tủ điện các loại, thiết bị trong nhà và ngoài trời cho dự án trọng điểm quốc gia, nhà máy thủy điện Hàm Thuận – Đa Mi 300MW



Tri An plant, 400MW
 Đang Nai, Vietnam (2003)



AVuong plant, 210MW
 Quang Nam, Vietnam (2006)



Móng Dương Thermal Power Plant 1,2 (2320MW)
 Nhà máy nhiệt điện Móng Dương 1,2 (2320 MW)

LSISVINA supplied a complete product and service package, included 12KV MFCB, DB, MCP, Busduct, indoor accessories, testing and installation during 2013 ~ 2016 to the first thermal power plant used CFB technology in Vietnam. EVN highly appreciates the quality and service provided.

LSISVINA cung cấp trọn gói sản phẩm và dịch vụ, bao gồm tủ 12KV MFCB, DB, MCP, hệ thống thanh nối, thiết bị trong nhà, thi nghiệm và lắp đặt trong thời gian 2013 – 2016 cho dự án nhà máy nhiệt điện đầu tiên sử dụng công nghệ CFB ở Việt Nam và được EVN đánh giá cao.



Vinh Tân 4, 1200MW
 Bình Thuận, Vietnam (2016)

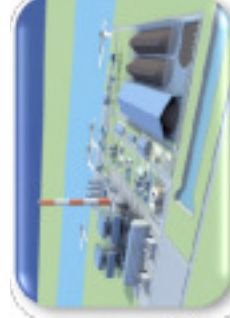

lang Phu 1, 1200MW
 Sóc Trăng, Vietnam (2017)



Hải Dương, 1200MW
 Hải Dương, Vietnam (2018)

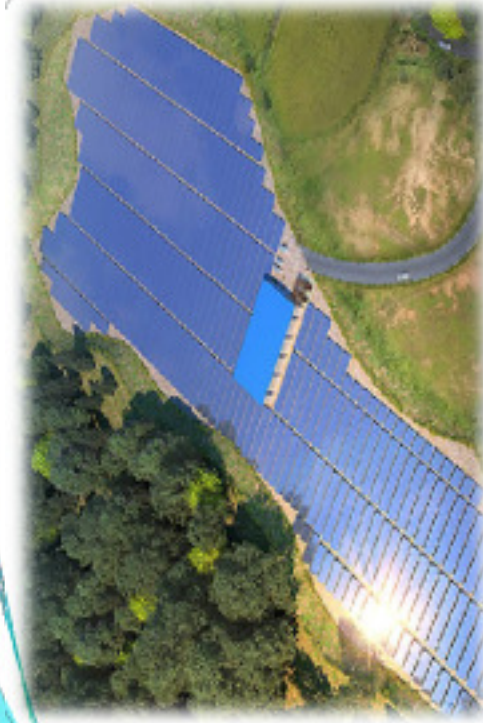

Yeongam Solar Power Plant 93MW – Korea
(Nhà máy điện mặt trời Yeongam 93MW – Hàn Quốc)



Tallin power plant - Siagang, Kaohsiung, Taiwan
(Nhà máy điện Tallin – Cao Hùng, Đài Loan)

LS ELECTRIC VIETNAM offer the best solution for solar power plants which does not only switchgear and component but also equipment for ESS (Energy Storage System).

LS ELECTRIC VIỆT NAM mang lại giải pháp tốt nhất cho các nhà sản xuất điện mặt trời, không chỉ là tủ điện, thiết bị mà còn cả trang thiết bị cho hệ thống tích trữ năng lượng.



Gelex plant, 42MW
Vietnam (2018)



Ninh Phuoc plant, 50MW
Vietnam (2019)



US Quang Tru plant, 50MW
Vietnam (2019)



Cam Lam plant, 50MW
Vietnam (2019)

2016 LS ELECTRIC VIETNAM entered Taiwan electric market with supplying equipment to 1,250MW thermal power plant that runs on fuel oil and natural gas, project owner - Taiwan Power.

Năm 2016, LS ELECTRIC VIỆT NAM bước chân vào thị trường điện Đài Loan bằng việc cung cấp thiết bị cho dự án nhà máy phát điện sử dụng dầu và khí gas tự nhiên, công suất 1.250MW do Điện lực Đài Loan là chủ đầu tư.



Maisel Coal-Fired Plant (880MW)
Indonesia (2016)

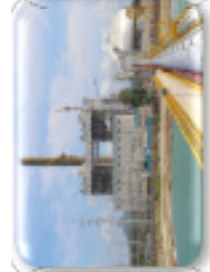

Trinava Visayas Plant (2,150MW)
Myanmar (2017)



Sa-nulia Geothermal Plant (110MW)
Indonesia (2016 - 2017)



Mela to CCGT Plant (2,242 MW)
Indonesia (2018-2019)

Experience

(Kinh nghiệm)

LS ELECTRIC

220kV/110kV/GIS substation

Trạm điện 220kV/110kV/GIS



220kV Phu Binh s/s – Thai Nguyen
(Trạm 220kV Phú Bình – Thái Nguyên)

LS ELECTRIC VIETNAM offers optimal products, especially 24kV MCSG switchgear is preferable used in 220kV substations for connecting transmission and distribution in the grid of Vietnam.

LS ELECTRIC VIỆT NAM cung cấp sản phẩm tối ưu, đặc biệt tủ 24kV MCSG được ưu tiên sử dụng trong các trạm 220kV cho việc kết nối truyền tải với phân phối trong hệ thống lưới điện Việt Nam.



220kV Phu noi S/s
Hung Yen, Vietnam

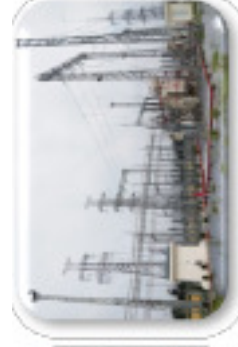

220kV Lang Bien S/s
Hanoi, Vietnam



220kV Da Luang S/s
Nghê An, Vietnam



110kV GIS Vinh Yen 2 substation (2015)
Trạm 110kV GIS Vĩnh Yên 2 (2015)

LS ELECTRIC VIETNAM as the first supplier in Vietnam offers GIS SF6 equipment, an advanced technology and much suitable for city, where contains big consumption but narrow space for construction and installation of normal substation.

LS ELECTRIC VIỆT NAM, nhà cung cấp đầu tiên ở Việt Nam bàn giao các thiết bị GIS SF6, một công nghệ tân tiến và rất phù hợp cho các thành phố, nơi có công suất tiêu thụ điện lớn nhưng giới hạn không gian, diện tích cho xây dựng trạm điện kiểu truyền thống.



110kV GIS Ba Ha
Hoan Kiem, Hanoi (2003)



110kV GIS Binh Phu
Hochiminh (2007)



220kV/110kV GIS Binh Tan
Hochiminh (2008)



Samsung mobile factory in Bắc Ninh, Thái Nguyên
(Nhà máy Samsung tại Bắc Ninh, Thái Nguyên)

C-AIS switchgear and other compact equipments can satisfy key expectation of factory managers by compactness and efficient operation.

Tủ C-AIS và các sản phẩm tinh gọn có thể làm hài lòng các mong muốn chủ yếu của những nhà quản lý nhà máy xí nghiệp bởi sự tinh gọn và hiệu quả vận hành.



Lock&Lock Vina
Vung Tau, Vietnam



Gunung Gureda PT
Malaysia



LG Display
Haiphong, Vietnam



KEFT Cooper Foll
Korea



Lotte Centre Hanoi, Vietnam
(Tòa nhà Lotte Centre Hanoi, Việt Nam)

Diverse application of product of LS ELECTRIC VIETNAM has been presenting in even biggest or normal Hotel, Building, Apartment, Campus, Hospital, Stadium available in Vietnam and other countries in the Asia.

Ứng dụng đa dạng của sản phẩm LS ELECTRIC VIỆT NAM đã và đang hiện diện từ quy mô nhỏ tới lớn các khách sạn, Tòa nhà, Chung cư, Khu phức hợp, Bệnh viện, Sân vận động ở Việt Nam và nhiều nước trong khu vực.



Keangnam Hanoi
Vietnam



Amara Yangon Hotel
Myanmar



POSTECH university
Korea



Royal City
Vietnam



- ❖ **PROJECT NAME : PECC2 BESS System**
- ❖ **SITE : PECC2's Engineering Design Centre, Vietnam**
- ❖ **PERIOD : TBD**
- ❖ **SCOPE OF WORK : ESS System**
 - Capacity : PCS 750kW, Battery 2.525MWh
 - Supply SWGR, Transformer, PCS, Battery, PMS and ESS Container
 - Installation for all equipment
 - AC/DC cabling, grounding work, lightning protection
 - Communication and CCTV system.



Banjarmasin international airport, Indonesia
(Sân bay quốc tế Banjarmasin, Indonesia)



Viet Trilwaste water treatment plant - Phu Tho, Vietnam
(Nhà máy thu gom xử lý nước thải Việt Trì) - Phú Thọ, Việt Nam

MV switchgear of LS ELECTRIC VIETNAM satisfy requirement of international airport by smart technology, neat design suitable to elegant appearance in this place.

Tủ trung thế của LS ELECTRIC VIỆT NAM làm hài lòng các yêu cầu của sân bay quốc tế bởi công nghệ thông minh, thiết kế tinh tế phù hợp với diện mạo thanh lịch tại các sân bay.



Semarang airport
Indonesia



Can Tho airport
Vietnam



Siem Reap airport
Cambodia



Pattimura Ambon airport
Indonesia

Product of LS ELECTRIC VIETNAM is used in multiple different industries, which is not limited by seaport, water treatment factory, gas processing plant.

Sản phẩm của LS ELECTRIC VIỆT NAM được ứng dụng trong nhiều ngành khác nhau, không chỉ giới hạn trong cảng biển, nhà máy xử lý nước, nhà máy xử lý khí gas.

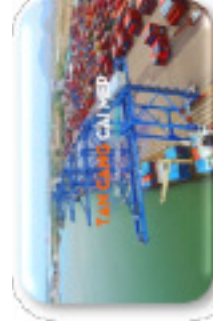

Cai Mep seaport
Vung Tau, Vietnam



Thiên Tân water factory
Dong Nai, Vietnam



Ca Mau gas processing plant
Ca Mau, Vietnam

Power Solution | **Systems** | HV S/S System

LS Electric sản xuất dải sản phẩm đồng bộ cho việc sản xuất, truyền tải, phân phối điện, bao gồm hệ thống GIS, Máy biến áp lực, Tủ điện trung thế



Management S/W Platform

- SCADA system (PGMS, PDPS, SAS, ECMS)
- Integrated on-line diagnosis system
- Substation Automation Sys.



Gas Insulated SWGR

- Up to 420kV / 63kA / 6300A
- IEC 62271-200

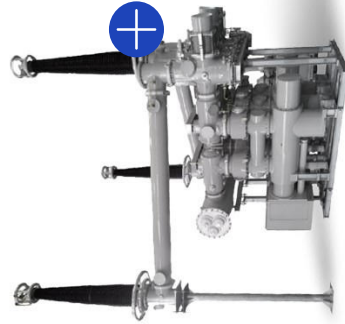

HV Power Transformer

- Up to 550kV 800MVA
- IEC 60076, ANSI/IEEE C57
- Special purpose : Scott connection, Electric furnace, Shunt reactor, HVDC converter transformer

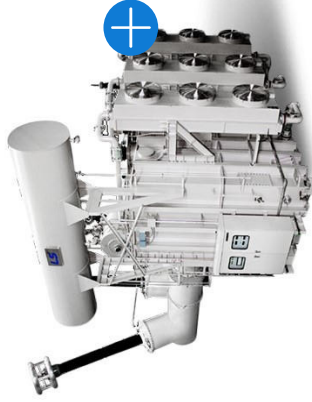

MV SWGR (MCSG)

- Up to 36kV / 50kA / 5000A
- IEC 62271-200, ANSI/IEEE C37



Power Solution | **Systems** | Distribution S/S System

Giải pháp cho lưới điện phân phối theo chuẩn quốc tế: IEC, ANSI

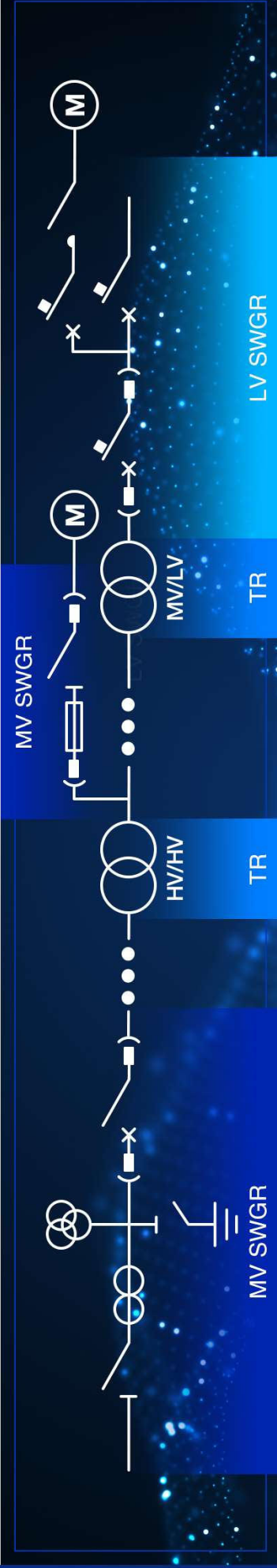

Management S/W Platform

- SCADA system (PQMS, PDPS, SAS, ECMS)
- Integrated on-line diagnosis system
- Substation Automation Sys.



DAU

SCADA

MV Switchgear

- Up to 36kV(RMU)/24kV(C-AIS)
- Up to 36kV/50kA/5000A(MCSG)
- IEC 62271-200



RMU

MCSG

C-AIS

Distribution Transformer

- Up to 33kV 3150kVA
- IEC 60076, IEEE C57
- Special-purpose :
Subway power supply /
Ground / Ship / VVVF etc.

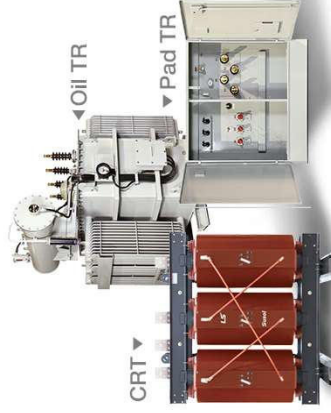

CRT

Oil TR

Pad TR

LV Switchgear

- Up to 100kA/Form 4b/IP54
- IEC 61439-1 & 2
- Smart Switchgear



Busway



Power Solution | Systems | PV-ESS

LS ELECTRIC has secured the core competencies of ESS by smart energy buildings in various application fields based on its profound experience in energy industry.

Trở thành nhà thầu Turn-key cho các dự án năng lượng thông minh, LS Electric có thể cung cấp đồng bộ giải pháp về sản phẩm, kỹ thuật, tư vấn và vận hành. Cốt lõi là hệ thống ESS đã được ứng dụng trong nhiều lĩnh vực

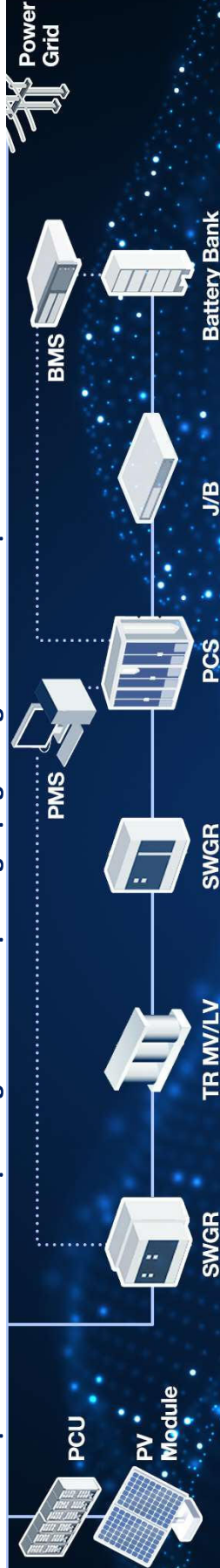

Management S/W Platform

- ▶ Web monitoring system
- ▶ PMS (Power Management)
- ▶ BMS (Battery Management)



Photovoltaic System

- ▶ Land / Floating / Rooftop type
- ▶ PV Tracker
- ▶ PCU from 13kW to 2MW 315Vdc



Energy Storage System

- ▶ Up to 2MW 380V/440V
- ▶ 125kW PEBB Module type



DC Component



Power Solution | Devices

LS ELECTRIC is proving its competitive edge through various products developed and produced based on technology of electric power supply in both domestic market and overseas market.

Protection·Measurement·Meter

GIPAM 115	GIPAM 3000	X-GIPAM
GIMAC 1000	GIMAC II Plus	GIMAC-V
GIMAC-B	Digital WHM	AMRS
GMP	DMPi	IMP
MMP	Gateway	M LINK
Data Device	E TAG	

Low Voltage

SPD	DIN Type	Box Type	MCB	CP
Metasol Contactor	Soft Starter	Metasol MCCB	ROCB	Susol Compact ACB
Metasol MCB/ELCB	Susol MCB	Susol Compact ACB	DC Devices	

Medium Voltage

Susol VCB	Susol VCS
LBS / ASS	Power Fuse
ALTS	GLBS / SLBS

LS-ELECTRIC đang chứng tỏ lợi thế cạnh tranh của mình thông qua các sản phẩm được phát triển và sản xuất dựa trên công nghệ cung cấp điện ở thị trường trong nước và thị trường nước ngoài

EMS – Energy Management System

Application in small unit such as: Homes (HEMS), Building (BEMS), Factory (FEMS) to reduce energy & CO2 gas emission

Highlights

- System redundancy support
- IEC 61850-compliant electrical equipment control and monitoring system
- User oriented application
 - Hỗ trợ dự phòng hệ thống
 - Hệ thống điều khiển và giám sát thiết bị điện tuân thủ IEC 61850
 - Ứng dụng định hướng người dùng
 - Truy cập hệ thống cục bộ và từ xa
 - Thực hiện hỗ trợ từ xa
- Monitor real-time data
- Receive and acknowledge faults, alarms and warnings
- Diagnose the health of individual modules, racks and system
 - Giám sát dữ liệu thời gian thực
 - Nhận và xác nhận lỗi, cảnh báo và cảnh báo
 - Chẩn đoán tình trạng của các mô-đun, giá đỡ và hệ thống riêng lẻ

Application of EMS: BEMS Building Energy management system

A green building with up-to-date smartgrid technologies to reduce energy and CO2 gas emission for LSIS R&D Campus

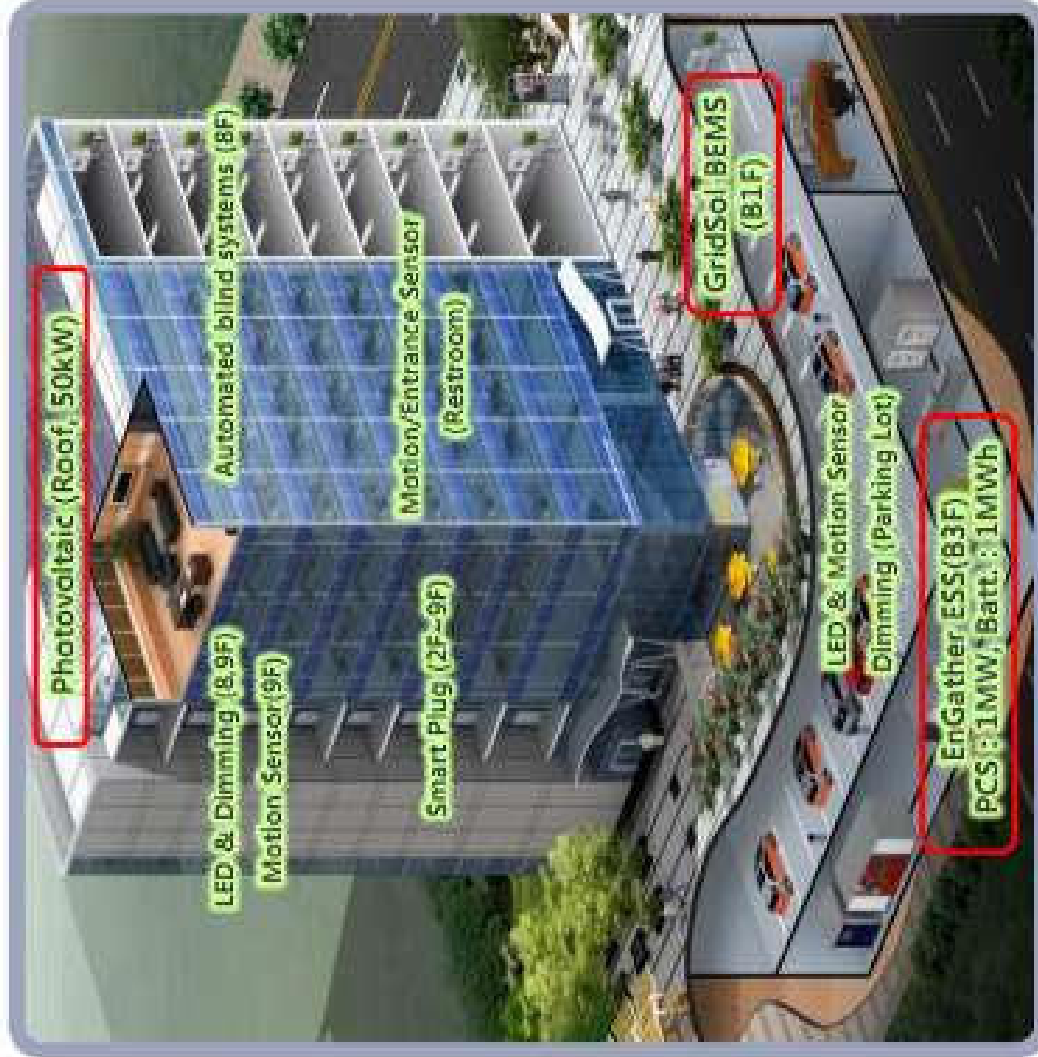

- Buildings spend 9% of total energy consumption
- Green buildings can reduce 15% of energy compared to traditional buildings
- 20% or more of energy is for lights.
 - LED lamps spend 30% less of fluorescent lamps, 85% less of incandescent lamps



Expected Savings

Description	Item	Amount(USD)
Yearly Savings	ESS	37,000
	Photovoltaic	7,800
	BEMS	29,900
Total Savings	Lighting	20,900
		95,600

Application of EMS: FEMS Factory Energy management system

The factory that incorporates low-carbon energy resources, environment-friendly devices and energy management system to minimize greenhouse gas emission, waste of energy, and environmental pollution



- Factories spend 29% of total energy, and generate 34% of total greenhouse gas
- 20 Millions of industrial motors spend 65% of energy spent in industry
- AC Drive can reduce 60% of energy used by pumps and fans



Expected Savings

Description	Item	Amount(USD)
Yearly Savings	ESS	62,000
	Photovoltaic	692,000
	Analysis/Management	181,000
Total Savings		935,000