

WHEN TECHNOLOGY CONNECTS, SO DOES HUMANITY.

TE CONNECTIVITY
2022 COMPANY OVERVIEW

EVERY CONNECTION COUNTS

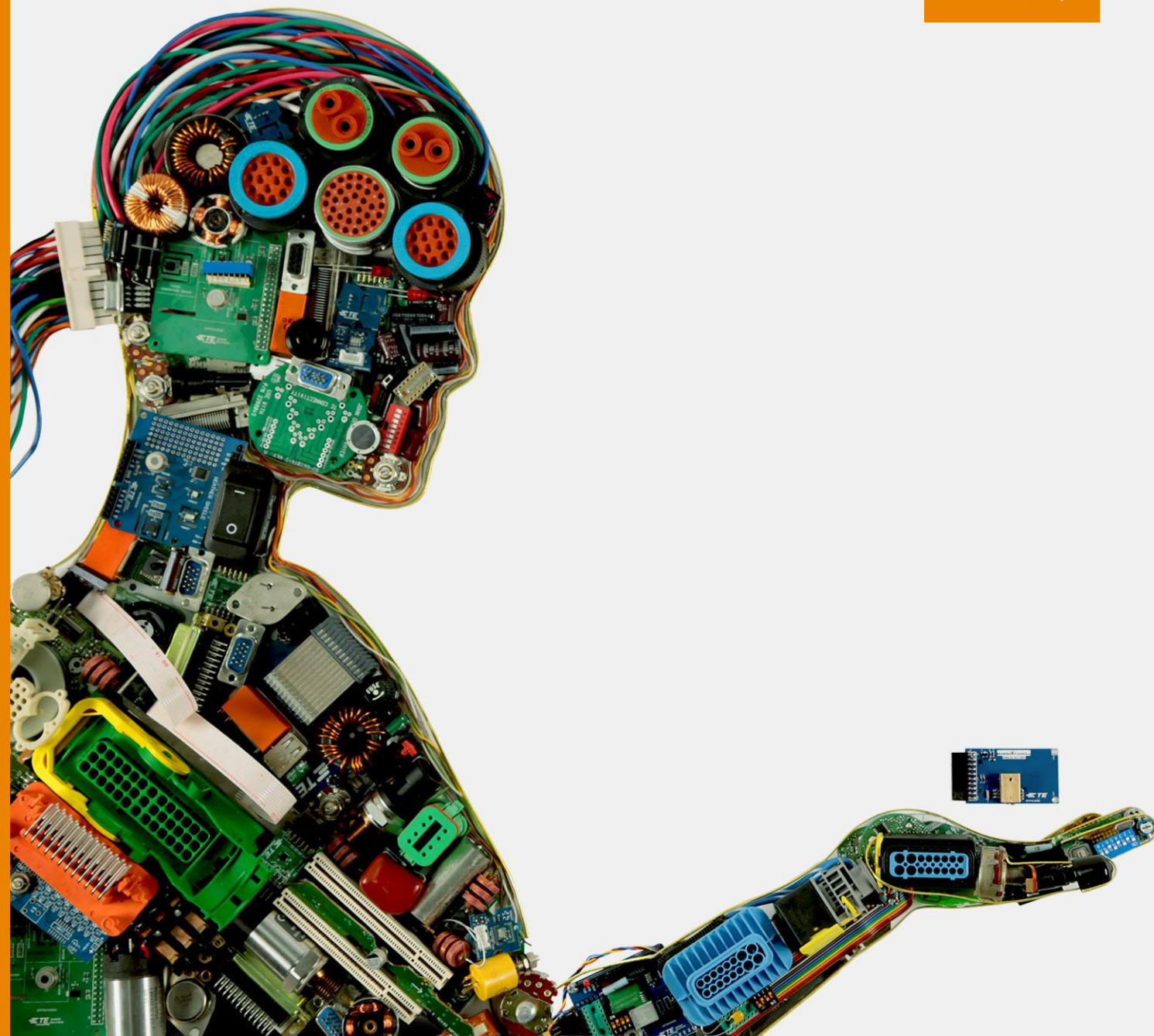

OUR PURPOSE

**WE CREATE
A SAFER,
SUSTAINABLE,
PRODUCTIVE AND
CONNECTED
FUTURE.**



**ADVANCING THE FUTURE
OF TRANSPORTATION**



**REVOLUTIONIZING
MEDICAL TECHNOLOGY**



**ENABLING GLOBAL
COMMUNICATION
NETWORKS**



**MAKING FACTORIES &
HOMES SMARTER**

\$2.1B

COMMUNICATIONS

Appliances, Data & Devices

\$3.8B

INDUSTRIAL

Industrial, Aerospace, Defense & Marine, Medical, Energy



\$9.0B

TRANSPORTATION

Automotive, Industrial & Commercial Transportation, Sensors, Application Tooling

**CONNECT
LIKE THE WORLD
DEPENDS ON IT.
BECAUSE IT DOES.**

247B

PRODUCTS MANUFACTURED ANNUALLY

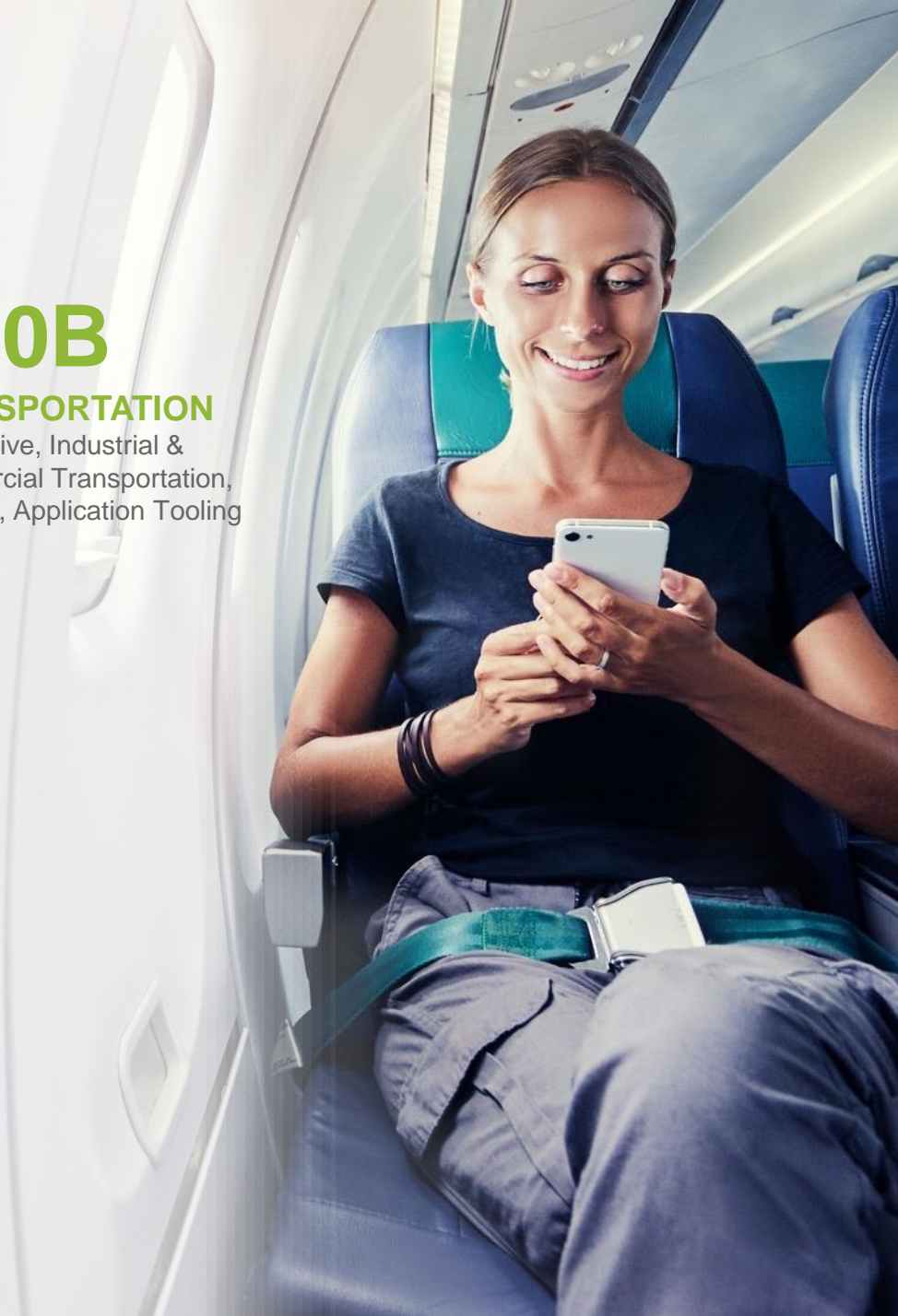

FY21 SALES BY REGION

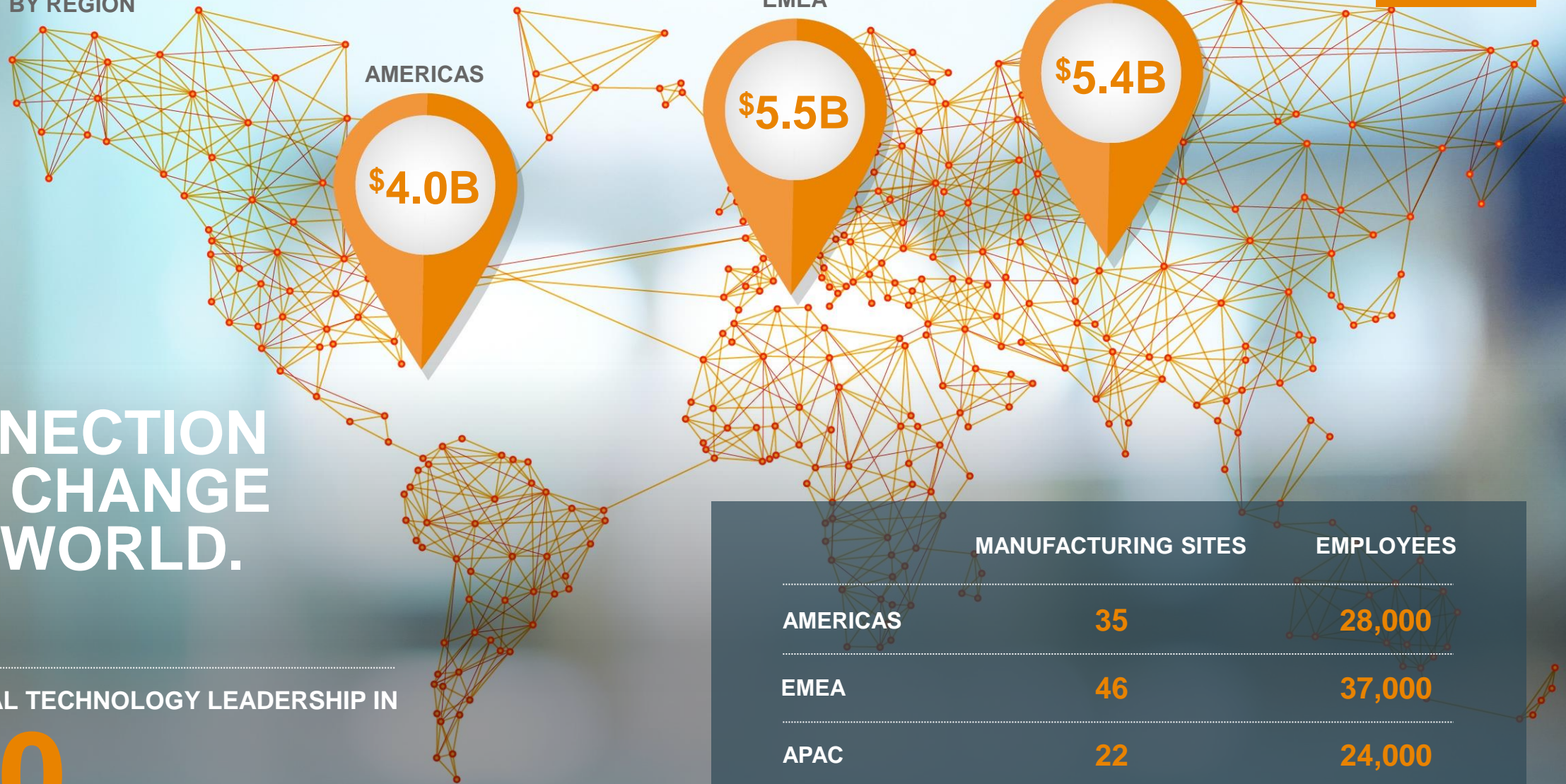

ANY CONNECTION CAN CHANGE THE WORLD.

INDUSTRIAL TECHNOLOGY LEADERSHIP IN

140

COUNTRIES

	MANUFACTURING SITES	EMPLOYEES
AMERICAS	35	28,000
EMEA	46	37,000
APAC	22	24,000



INDUSTRIAL TECHNOLOGY LEADERSHIP



15K+

PATENTS
granted or pending

\$675M+

INVESTED in engineering,
research & development

8000+

ENGINEERS
globally

Approximately

20%

of sales from
new products

All figures from financial year 2021

We Unleash the Potential of Every Connection



THE TE OPERATING ADVANTAGE (TEOA) PROVIDES VALUE TO CUSTOMERS BY OPTIMIZING:



QUALITY



SERVICE



DELIVERY



CUSTOMER SUPPORT

With Great Power Comes Great Sustainability



GREENHOUSE GAS INTENSITY
FY20 VS FY10



ENERGY USE INTENSITY
FY20 VS FY10



WATER USAGE
FY20 VS FY10



\$5.6M

GLOBAL CHARITABLE GIVING FY20

650K+

PEOPLE IMPACTED IN NEXT-GENERATION TECHNOLOGY EDUCATION FY20

\$2.1B

LOCAL ECONOMIC IMPACT FROM SUPPLY CHAIN FY20



Member of **Dow Jones Sustainability Indices**

Powered by the S&P Global CSA

Sustainability Yearbook
Member 2021

S&P Global

Unleashing Our Global Talent



We are committed to a safe, diverse and inclusive work environment where creativity, collaboration and innovation flourish.

OUR CORE VALUES

- INTEGRITY
- ACCOUNTABILITY
- TEAMWORK
- INNOVATION



ENERGY SOLUTIONS

**GRID CONNECTIVITY
+ RELIABILITY**

**ENERGY
BUSINESS UNIT**

An Nguyen

Account Manager - ENERGY

EVERY CONNECTION COUNTS

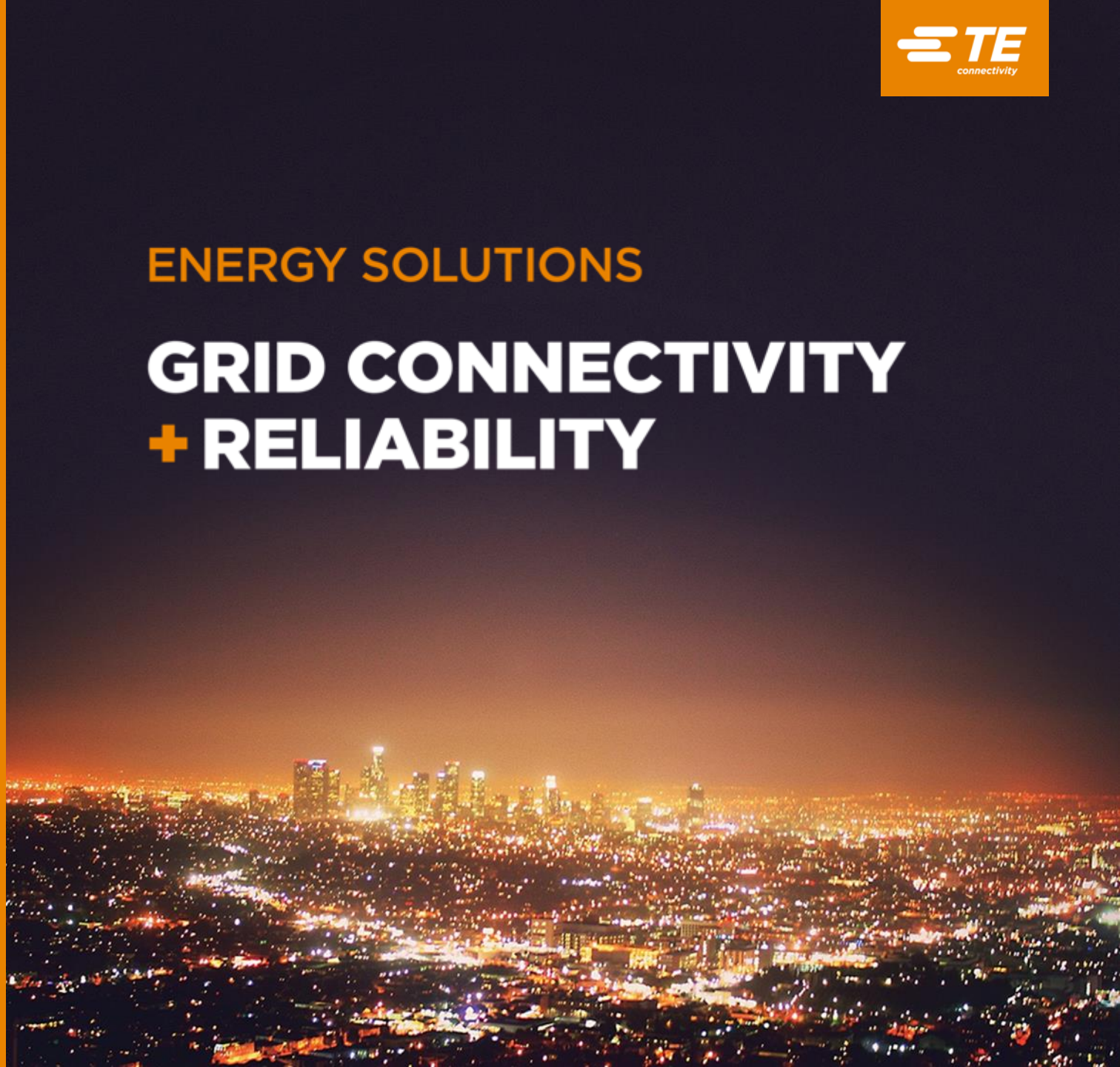

FULFILLING OUR PURPOSE IN ENERGY

WE CREATE
A SAFER,
SUSTAINABLE,
PRODUCTIVE AND
CONNECTED
FUTURE.



PROTECTING WILDLIFE
AND YOUR ASSETS



ADVANCING RENEWABLE
ENERGY

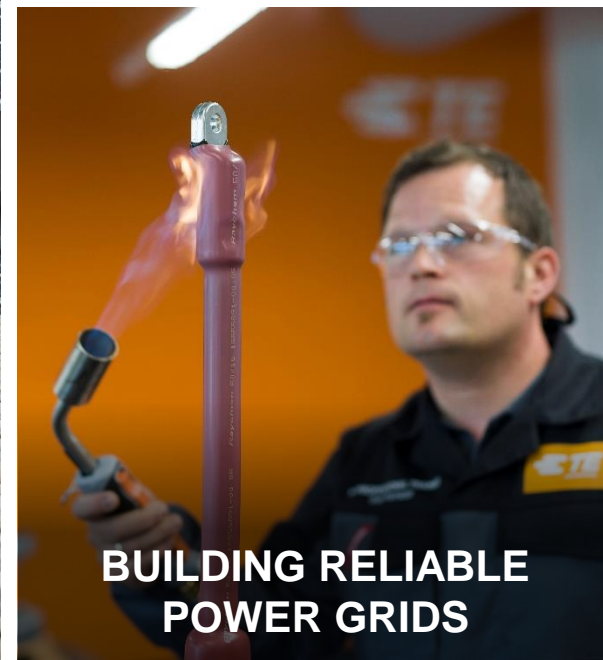

BUILDING RELIABLE
POWER GRIDS



ENABLING THE SMART
GRID OF THE FUTURE



ENERGY BUSINESS UNIT

CUSTOMERS RELY ON US TO INNOVATE SUSTAINABLE ENERGY NETWORKS AND KEEP THE POWER ON.



2900

EMPLOYEES
DEDICATED TO ENERGY

\$738M

ENERGY GLOBAL
REVENUE FY21

PARTNERING IN

130+

 COUNTRIES

WORLD'S top
Utilities, EPCs
and OEMs

WE ARE THE BRANDS YOU RELY ON

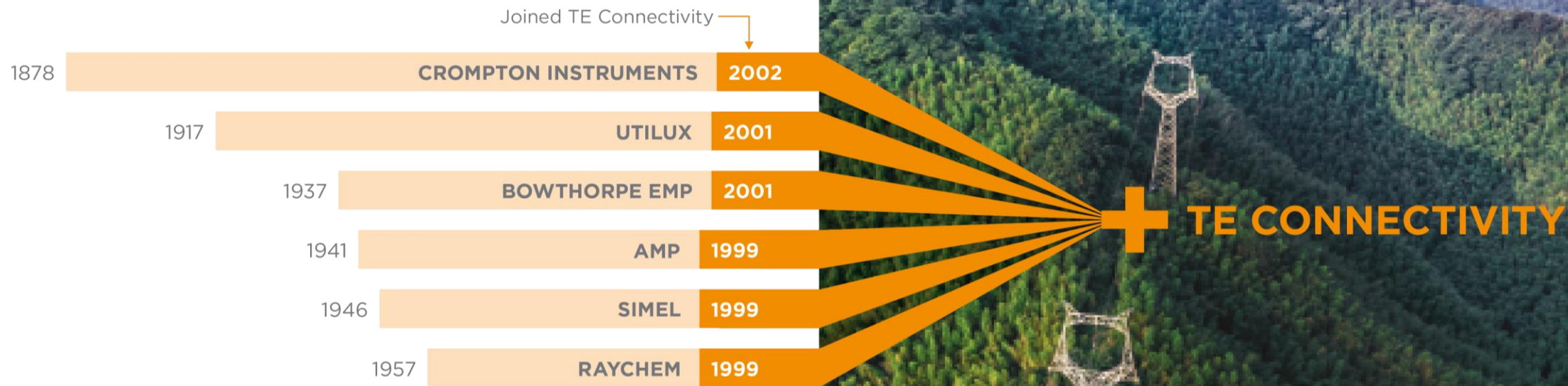

If you know Raychem,
You know TE Connectivity

INNOVATION + COLLABORATION

PIONEERING GRID RELIABILITY

- Engineering expertise
- In-house manufacturing
- Materials science and laboratory testing

If the ideal product isn't in our portfolio, we can customize a solution for your needs.



**Building a
customized
end-to-end
solution**



**Consult.
Design.
Test.
Train.**

GLOBAL MANUFACTURING COMPETENCIES



Heat Shrink Tubing



Machining



Molding



Thermoforming

EXTREMES + RELIABILITY

ANYWHERE DURABILITY

High voltage, UV exposure, extreme temperatures, salinity, humidity, smog:

Even in the harshest environments, our products deliver reliability that lasts the lifetime of your equipment.

This is thanks to decades of materials science experience and testing in our certified labs.



“I went back to a Raychem joint I installed 40 years ago and it was still in service”

Materials science for enhanced product performance



- Cross-linking
- Heat shrink tubing
- Non-tracking
- UV-stabilized
- Resin technologies
- Power gel technologies
- Electrical stress control

EVERY CONNECTION COUNTS

A failed transformer can easily cost you hundreds of thousands of dollars.

Utilities face expensive lawsuits for the wildfires they cause. The causes commonly reported are avoidable:

- Electrocuted wildlife, 10-12%
- Vegetation & conductor clashing, 15-30%

SOURCES:

REGULATOR REPORTS FROM CALIFORNIA, USA AND NEW SOUTH WALES, AUSTRALIA

**WINDFARM DOWNTIME COSTS:
YOU CAN LOSE \$1200 IN 24HRS IF A 1MW
TURBINE IS OUT OF OPERATION ON A
WINDY DAY**

SOURCE:

[HTTP://WWW.WINDUSTRY.ORG/COMMUNITY_WIND_TOOLBOX_8_COSTS](http://www.windustry.org/community_wind_toolbox_8_costs)

**\$10,000:
Average cost to
replace a medium
voltage joint**

WITH YOU EVERY STEP OF THE WAY TO KEEP YOUR GRID CONNECTED

+ EQUALS MORE

Comprehensive solutions and services for any voltage classes from a single partner:

- Cable Accessories
- Connectors & Fittings
- Insulation & Protection
- Metering
- Installation Training

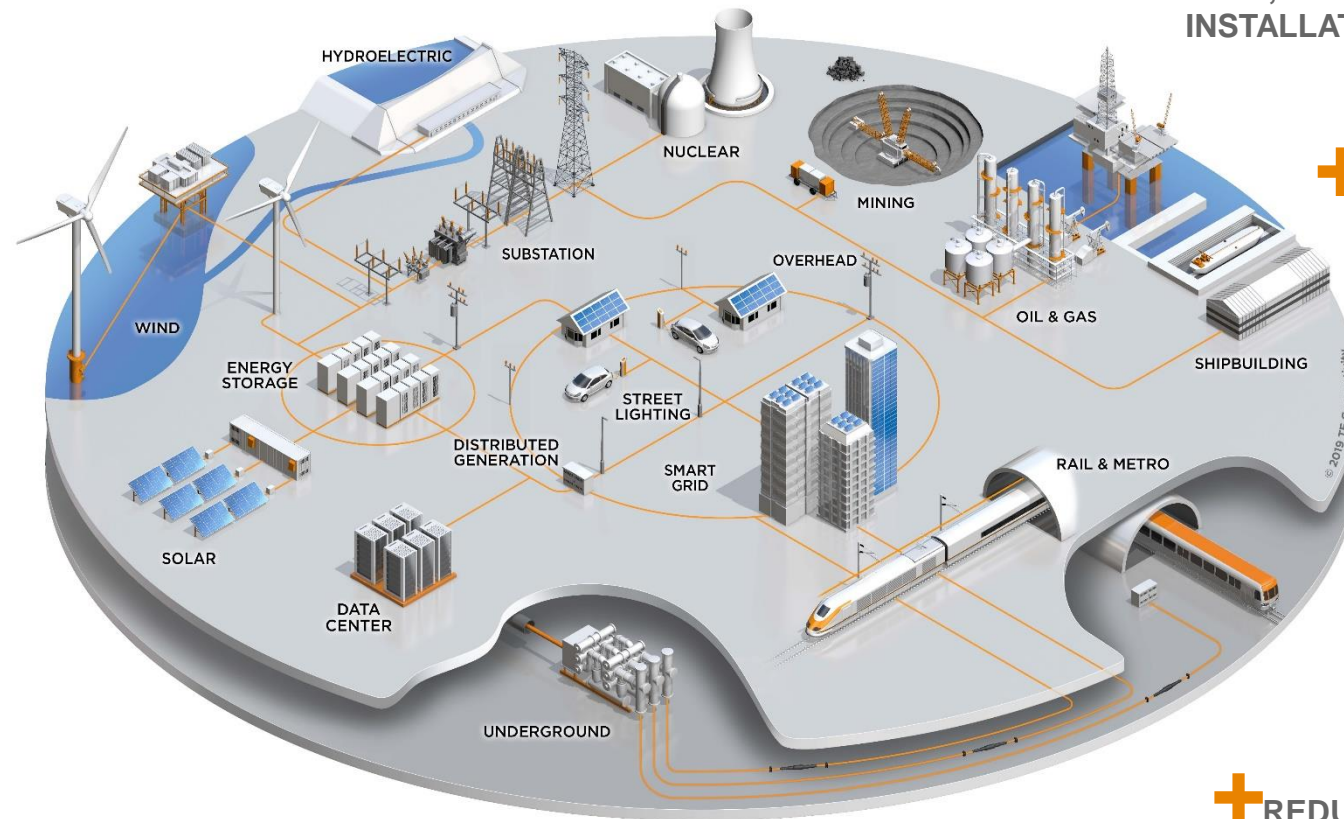

+ EASY, FAST, SAFE
INSTALLATIONS

+ WILDLIFE AND
ASSET PROTECTION

+ GRID MONITORING

+ GRID RELIABILITY

+ REDUCED COST
OF OWNERSHIP

+ INSTALLER & ENGINEERING
SUPPORT

With you every step of the way to keep your grid connected

Comprehensive solutions and services for all voltage classes from a single partner.



Cable Accessories



Connectors & Fittings



Insulation & Protection



Metering

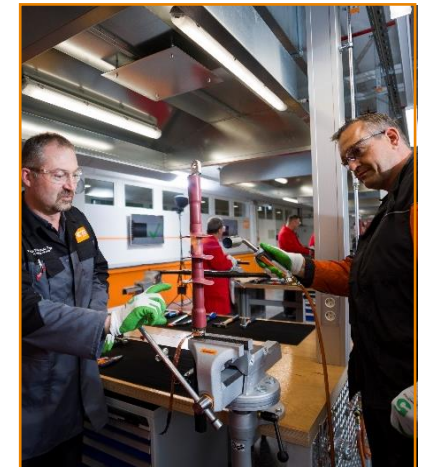

Installation Training

A Uniquely Broad Portfolio

Cable Accessories

- Our Raychem products feature a variety of insulating and sealing technologies
- Heat shrink, cold applied, gel, resin and casting materials
- Extensive switchgear connect offering, also with grid monitoring
- Suitable for low, medium and high voltage applications
- Ensuring reliability even in severe environments



Switchgear Connectors

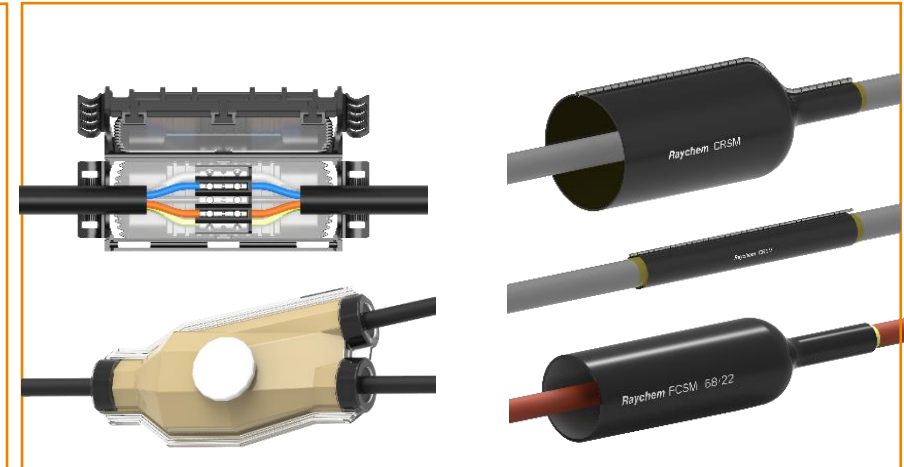

Heat Shrink and Cold Applied Components



Terminations



Joints / Splices

We are the inventors of heat shrink technology and we have nearly three decades of proven performance in cold applied technologies.

A Uniquely Broad Portfolio

Connectors & Fittings

- A wide range of AMP, SIMEL and UTILUX connection solutions
- Offering advanced crimp, shear bolt, wedge pressure, exothermic welding and insulation piercing – technologies that have revolutionized the industry
- For low, medium and high voltage applications



Crimp and Mechanical Connectors



HV Substation



Wedge Connectors

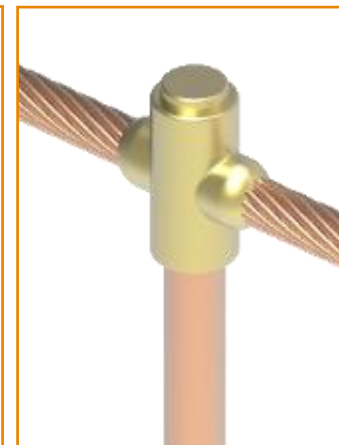

Grounding



Insulation Piercing

A Uniquely Broad Portfolio

Insulation & Protection

- Raychem insulators, wildlife and asset protection, Bowthorpe EMP surge arresters
- Advanced composite, ZnO and outdoor insulating materials
- Designed and optimized for use in polluted HV environments
- For high, medium and low voltage applications

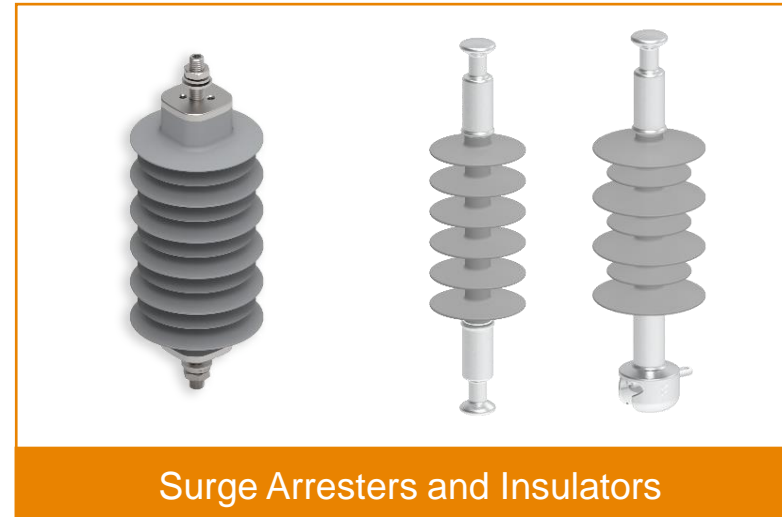

A Uniquely Broad Portfolio

Metering

- Optimizing energy consumption is increasingly important on the modern grid
- Our metering products offer high resolution, electronic power quality measurement
- Suitable for use across the entire energy supply chain



Current Transformers and Shunts



Analog Power Instrumentation



Electronic Power Instrumentation

A Uniquely Broad Portfolio

Installation Training

- Proper installation is a major factor in long-term product performance and grid reliability
- Our training programs help you to meet the highest safety standards, maximize operational lifespan and minimize maintenance costs
- We're able to respond quickly with training:
 - At our training centers
 - Through our distribution partners
 - At your training facilities
 - In-field at your installation site



1,500+

Installers trained each year for MV/HV Cable Accessories

50+ Technical Service Engineers training customers

5 Training Centers: China, France, Germany, Russia and USA

Connect With Us

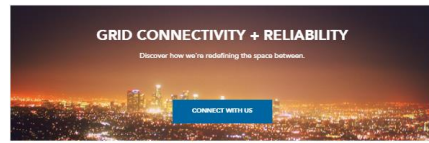

WHAT DOES GRID RELIABILITY DEPEND ON?

EVERY CONNECTION COUNTS

You're faced with daily challenges like unforgiving environments, installation accuracy, constantly evolving technology and regulations, animal-induced outages. Will a tracked material cause a faultline - or worse, a wildfire? How will you manage the emerging trends of deenergization, urbanization, network densification, digitalization? When you're tasked with building the grid of the future - robust, intelligent and emission-free - it's clear that every connection counts.

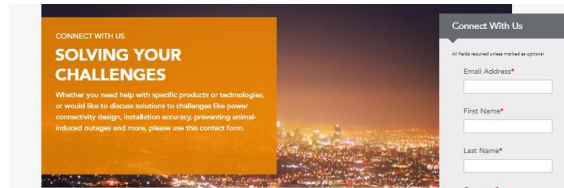

Customer Care
Energy Products

AMERICAS

- USA / Canada +1 800.527.4968
- Brazil +55 11 2103.6252
- Mexico +52 55 1106 3000
- Central / South America +54 (0) 11 2192 1700



[TE.com/energy](https://te.com/energy)

[TE.com/energy-contact](https://te.com/energy-contact)



Q&A Session

Join our experts from engineering, product development, product management and sales to learn more about how we can help you address the challenges you face when designing, building and maintaining your energy projects. Each webinar will focus on a specific solution area or technical topic and will offer an opportunity for Q&A. We're also happy to follow up with you and your team to provide more in-depth answers to your specific situation and requirements. For each live webinar you attend, you will receive a certificate of completion with Professional Development Hours where applicable. Check this site regularly - we continuously add topics to our schedule.



[TE.com/webinar-series](https://te.com/webinar-series)



SEPARABLE CONNECTORS

TE'S BAYONNETT CONNECTORS FOR TELECOM

TE'S AMPHENOL SERIES AND SEPARABLE CONNECTORS FOR NEW APPLICATIONS

TE'S BAYONNETT SERIES AND SEPARABLE CONNECTORS FOR RIGID APPLICATIONS



[TE.com/installationvideos](https://te.com/installationvideos)

An. Nguyen Thanh
Account Manager - ENERGY
Email: an.nguyethanh@te.com
Phone: (+84) 976 848 567

EVERY CONNECTION COUNTS

